

Vectron International**Filter specification****TFS1227B****1/5****Measurement condition**

Ambient temperature T_A :	23	°C
Input power level:	0	dBm
Terminating impedance:		
Input:	50	Ω
Output:	50	Ω

Characteristics

Remark:

The maximum attenuation in the pass band is defined as the insertion loss a_e . The nominal frequency f_N is fixed at 1227.6 MHz without any tolerance or limit. The values of absolute attenuation a_{abs} are guaranteed over the whole operating temperature range. The frequency shift of the filter within the operating temperature range is included in the production tolerance scheme.

D a t a		typ. value		tolerance / limit		
Insertion loss within PB1	a_{e1}	2.4	dB	max.	4.0	dB
Insertion loss within PB2	a_{e2}	1.5	dB	max.	2.0	dB
Nominal frequency	f_N	-			1227.6	MHz
Passband 1	PB ₁	-		$f_N \pm$	12.0	MHz
Passband 2	PB ₂	-		$f_N \pm$	5.0	MHz
Passband variation within PB1	PBV ₁	0.4	dB	max.	1.0	dB
Absolute attenuation	a_{abs}					
0.3 MHz ... 1127.0 MHz		43	dB	min.	32	dB
1127.0 MHz ... 1167.0 MHz		49	dB	min.	42	dB
1167.0 MHz ... 1177.0 MHz		46	dB	min.	32	dB
1197.6 MHz		25	dB	min.	6	dB *)
1257.6 MHz		35	dB	min.	11	dB **)
1277.0 MHz ... 1287.0 MHz		55	dB	min.	32	dB
1287.0 MHz ... 1327.0 MHz		54	dB	min.	42	dB
1327.0 MHz ... 3000.0 MHz		37	dB	min.	32	dB
Group delay ripple within PB1	GDR ₁	35	ns	max.	50	ns
Group delay ripple within PB2	GDR ₂	12	ns	max.	30	ns
VSWR within PB		1.6 : 1		max.	2 : 1	
Input power level in PB		-		max.	15	dBm
Operating temperature range	OTR	-			-45 °C ... +85 °C	
Storage temperature range		-			-55 °C ... +125 °C	
Temperature coefficient of frequency	TC_f^{***}	-42	ppm/K			

*) stop band attenuation between 1177.0 MHz and 1197.6 MHz decreases linearly from 32 dB to 6 dB

**) stop band attenuation between 1257.6 MHz and 1277.0 MHz increases linearly from 11 dB to 32 dB

***) $\Delta f = TC_f(T - T_A)f_N$

Generated:**Checked / Approved:**

Vectron International GmbH
Potsdamer Straße 18
D 14 513 TELTOW / Germany
Tel: (+49) 3328 4784-0 / Fax: (+49) 3328 4784-30
E-Mail: tft@vectron.com

Vectron International GmbH reserves the right to make changes to the product(s) and/or information contained herein without notice. No liability is assumed as a result of their use or application. No rights under any patent accompany the sale of any such product(s) or information.

Filter characteristic

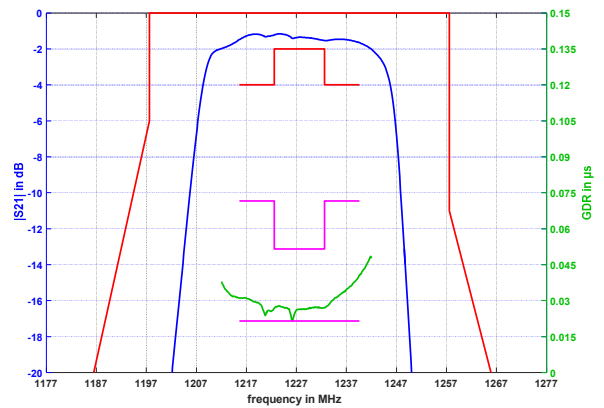
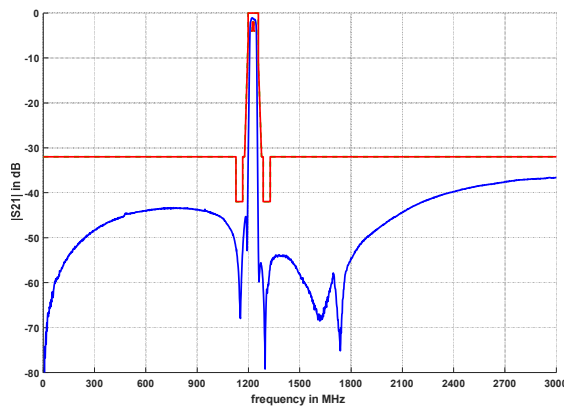

Construction and pin connection

(All dimensions in mm)

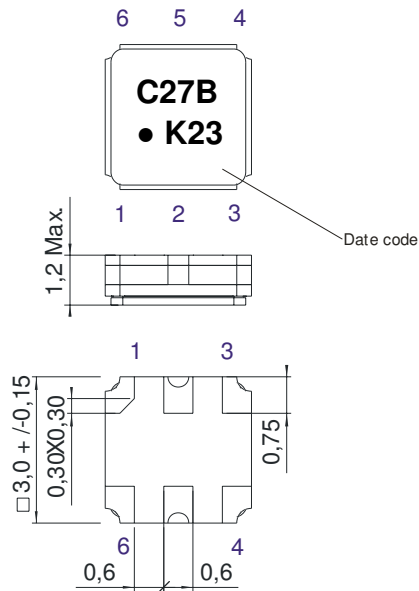

- 1 Ground
- 2 Input
- 3 Ground
- 4 Ground
- 5 Output
- 6 Ground

- Date code: Year + week
- K 2018
 - L 2019
 - M 2020
 - ...

50 Ω Test circuit

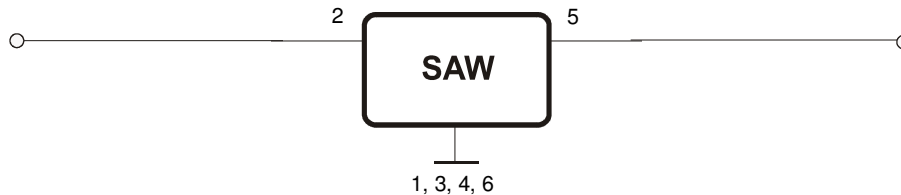

Vectron International GmbH
 Potsdamer Straße 18
 D 14 513 TELTOW / Germany
 Tel: (+49) 3328 4784-0 / Fax: (+49) 3328 4784-30
 E-Mail: tft@vectron.com

Vectron International GmbH reserves the right to make changes to the product(s) and/or information contained herein without notice. No liability is assumed as a result of their use or application. No rights under any patent accompany the sale of any such product(s) or information.

Stability characteristics. reliability

After the following tests the filter shall meet the whole specification:

1. Shock: 500 g, 1 ms, half sine wave, 3 shocks each plane;
DIN IEC 60068 T2 - 27
2. Vibration: 10 Hz to 2000 Hz, 0.35 mm or 5 g respectively, 1 octave per min. 10 cycles per plane, 3 planes; DIN IEC 60068 T2 - 6
3. Change of temperature: -55 °C to 125 °C / 15 min. each / 100 cycles
DIN IEC 60068 part 2 – 14 Test N
4. Resistance to solder heat (reflow): reflow possible: three times max.;
for temperature conditions refer to the attached "Air reflow temperature conditions" on page 4;
5. SAW devices are Electrostatic Discharge (ESD) sensitive devices.

This filter is RoHS compliant (2011/65/EU)

Packing

Tape & Reel: IEC 286 – 3, with exception of value for N and minimum bending radius;
tape type II, embossed carrier tape with top cover tape on the upper side;

reel of empty components at start:	min. 300 mm
reel of empty components at start including leader:	min. 500 mm
trailer:	min. 300 mm

Tape (all dimensions in mm)

W	:8.00	±0.3
Po	:4.00	±0.1
Do	:1.50	+0.1/-0
E	:1.75	±0.1
F	:3.50	±0.05
G(min)	:-0.75	
P2	:2.00	±0.05
P1	:4.00	±0.1
D1(min)	:1.50	
Ao	:3.25	±0.1
Bo	:3.25	±0.1
Ct	:5.30	±0.1
Ko	:1.50	±0.1
t	:0.25	±0.05

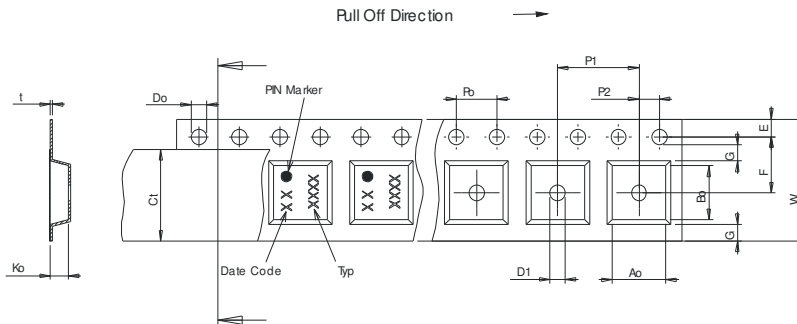

Reel (all dimensions in mm)

A	:330	or 180
W1	:8.40	+1.5/-0
W2(max)	:14.40	
N(min)	:60.00	
C	:13.0	±0.2

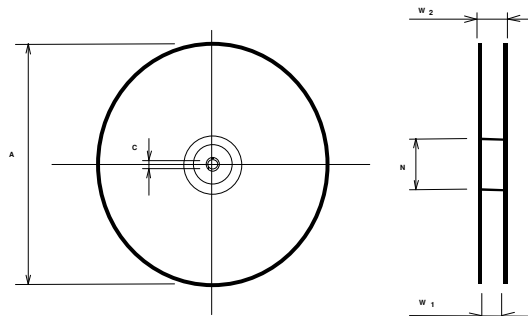

The minimum bending radius is 45 mm.

Vectron International GmbH
Potsdamer Straße 18
D 14 513 TELTOW / Germany
Tel: (+49) 3328 4784-0 / Fax: (+49) 3328 4784-30
E-Mail: tft@vectron.com

Vectron International GmbH reserves the right to make changes to the product(s) and/or information contained herein without notice. No liability is assumed as a result of their use or application. No rights under any patent accompany the sale of any such product(s) or information.

Air reflow temperature conditions

Conditions	Exposure
Average ramp-up rate (30 °C to 217 °C)	less than 3 °C / second
> 100 °C	between 300 and 600 seconds
> 150 °C	between 240 and 500 seconds
> 217 °C	between 30 and 150 seconds
Peak temperature	max. 260 °C
Time within 5 °C of actual peak temperature	between 10 and 30 seconds
Cool-down rate (Peak to 50 °C)	less than 6 °C / second
Time from 30 °C to Peak temperature	no greater than 300 seconds

Chip-mount air reflow profile

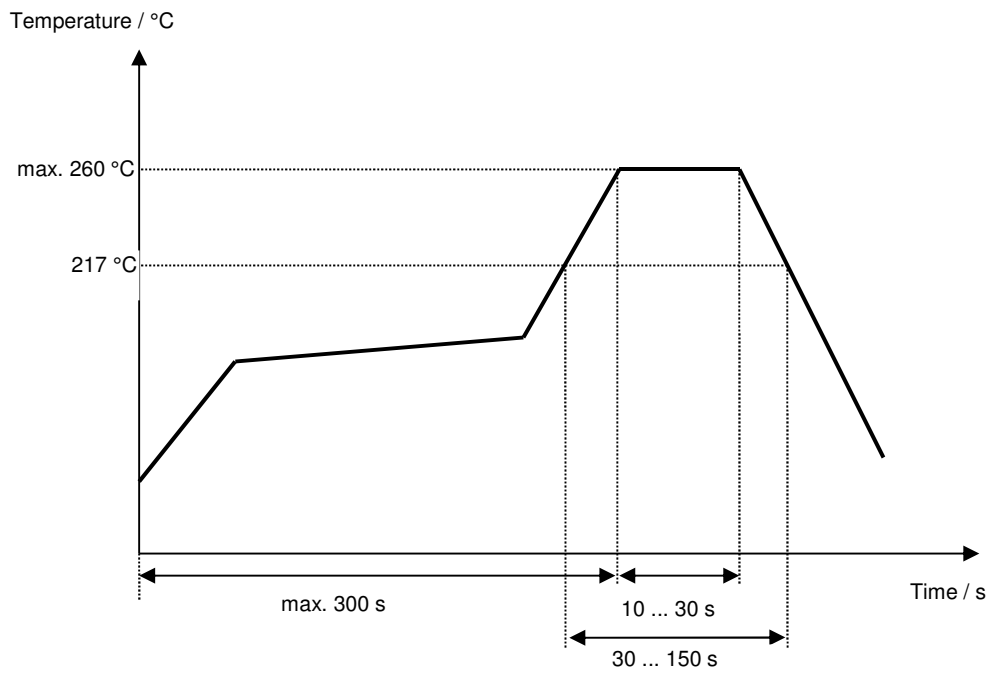

Vectron International GmbH
 Potsdamer Straße 18
 D 14 513 TELTOW / Germany
 Tel: (+49) 3328 4784-0 / Fax: (+49) 3328 4784-30
 E-Mail: tft@vectron.com

Vectron International GmbH reserves the right to make changes to the product(s) and/or information contained herein without notice. No liability is assumed as a result of their use or application. No rights under any patent accompany the sale of any such product(s) or information.

History

Version	Reason of Changes	Name	Date
1.0	- Generation of development specification	Noack	09.07.2010
2.0	- Change of data table according to new customer requirements	Noack	23.07.2010
3.0	- Change of data table according to new customer requirements	Noack	27.07.2010
4.0	- Change alignment of tape and reel - Add typical values and filter characteristic - Generation of filter specification	Noack	03.05.2011
5.0	- updated data table - updated package drawing - updated filter characteristics - updated stability characteristics - updated Tape & Reel	P. Jaster	07.06.2018
6.0	- updated filter characteristic - updated package	P. Jaster	11.06.2018