

Vectron International**Filter specification****TFS1245A****1/5****Measurement condition**

Ambient temperature T_A :	23	°C
Input power level:	0	dBm
Terminating impedance:		
Input:	200	Ω
Output:	200	Ω

Characteristics

Remark:

The maximum attenuation in the pass band is defined as the insertion loss a_e . The nominal frequency f_N is fixed at 1245.5 MHz without any tolerance or limit. The values of absolute attenuation a_{abs} are guaranteed over the whole operating temperature range. The frequency shift of the filter within the operating temperature range is included in the production tolerance scheme.

D a t a		typ. value		tolerance / limit	
Insertion loss in PB1	a_e	1.5	dB	max.	3.0 dB
Nominal frequency	f_N	-			1245.5 MHz
Passband 1	PB1	-		$f_N \pm$	8.5 MHz
Passband 2	PB2	-		$f_N \pm$	4.0 MHz
Passband variation within PB1	PBV ₁	0.3	dB	max.	2.0 dB
Absolute attenuation	a_{abs}				
0.3 MHz ... 1205.0 MHz		35	dB	min.	32 dB
1285.0 MHz ... 2500.0 MHz		40	dB	min.	35 dB
Group delay ripple within PB1	GDR1	6	ns	max.	20 ns
Group delay ripple within PB2	GDR2	3	ns	max.	10 ns
Group delay variation (unit to unit)	*)	+/- 2	ns	max.	+/- 4 ns
VSWR within PB1		1.9 : 1		max.	2.3 : 1
Input power level in PB1		-		max.	20 dBm
Operating temperature range	OTR	-			-40 °C ... +85 °C
Storage temperature range		-			-55 °C ... +125 °C
Temperature coefficient of frequency	TC_f **)	-44	ppm/K		

*) measured at: f_N , $f_N + 4$ MHz, $f_N - 4$ MHz

**) $\Delta f = TC_f(T - T_A)f_N$

Generated:

Checked / Approved:

Vectron International GmbH
Potsdamer Straße 18
D 14 513 TELTOW / Germany
Tel: (+49) 3328 4784-0 / Fax: (+49) 3328 4784-30
E-Mail: tft@vectron.com

Vectron International GmbH reserves the right to make changes to the product(s) and/or information contained herein without notice. No liability is assumed as a result of their use or application. No rights under any patent accompany the sale of any such product(s) or information.

Filter characteristic

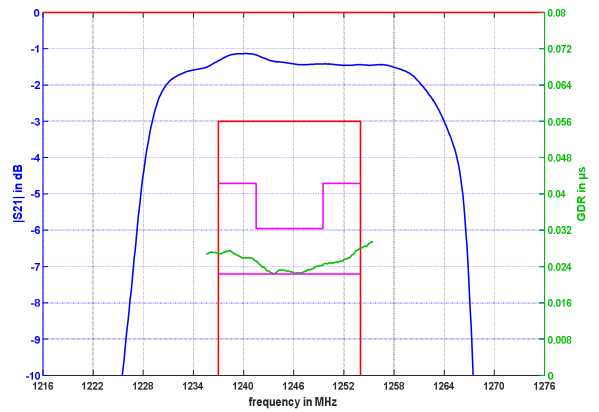
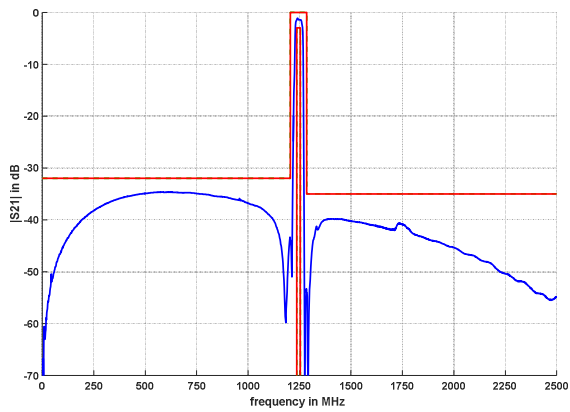

Construction and pin connection

(All dimensions in mm)

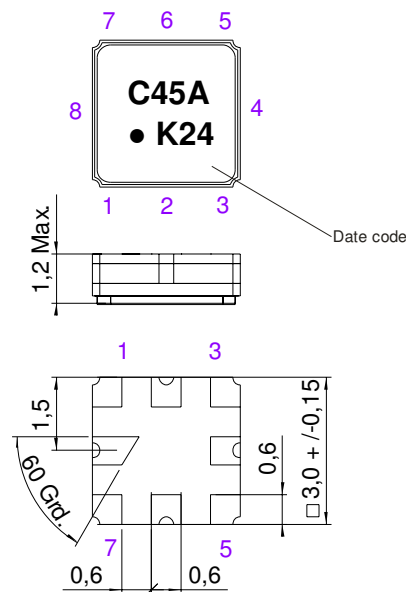

- 1 Input 1
- 2 Ground
- 3 Input 2
- 4 Ground
- 5 Output 1
- 6 Ground
- 7 Output 2
- 8 Ground

Date code: Year + week
 K 2018
 L 2019
 M 2020
 ...

200 Ω Test circuit

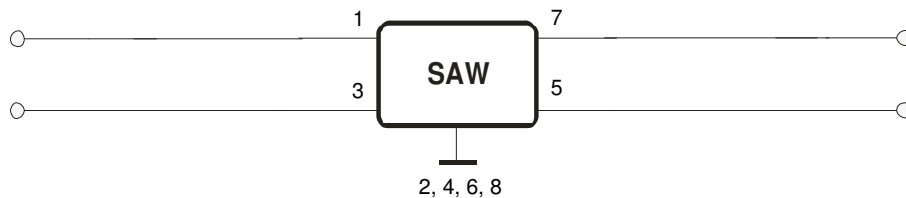

Vectron International GmbH
 Potsdamer Straße 18
 D 14 513 TELTOW / Germany
 Tel: (+49) 3328 4784-0 / Fax: (+49) 3328 4784-30
 E-Mail: tft@vectron.com

Vectron International GmbH reserves the right to make changes to the product(s) and/or information contained herein without notice. No liability is assumed as a result of their use or application. No rights under any patent accompany the sale of any such product(s) or information.

Stability characteristics, reliability

After the following tests the filter shall meet the whole specification:

1. Shock: 500 g, 1 ms, half sine wave, 3 shocks each plane;
DIN IEC 60068 T2 - 27
2. Vibration: 10 Hz to 2000 Hz, 0.35 mm or 5 g respectively, 1 octave per min, 10 cycles per plane, 3 planes; DIN IEC 60068 T2 - 6
3. Change of temperature: -55 °C to 125 °C / 15 min. each / 100 cycles
DIN IEC 60068 part 2 – 14 Test N
4. Resistance to solder heat (reflow): reflow possible: three times max.;
for temperature conditions refer to the attached "Air reflow temperature conditions" on page 4;
5. SAW devices are Electrostatic Discharge (ESD) sensitive devices.

This filter is RoHS compliant (2011/65/EU)

Packing

Tape & Reel: IEC 286 – 3, with exception of value for N and minimum bending radius;
tape type II, embossed carrier tape with top cover tape on the upper side;

reel of empty components at start: min. 300 mm
reel of empty components at start including leader: min. 500 mm
trailer: min. 300 mm

Tape (all dimensions in mm)

W	:8.00 ±0.3
Po	:4.00 ±0.1
Do	:1.50 +0.1/-0
E	:1.75 ±0.1
F	:3.50 ±0.05
G(min)	:0.75
P2	:2.00 ±0.05
P1	:4.00 ±0.1
D1(min)	:1.50
Ao	:3.25 ±0.1
Bo	:3.25 ±0.1
Ct	:5.30 ±0.1
Ko	:1.50 ±0.1
t	:0.25 ±0.05

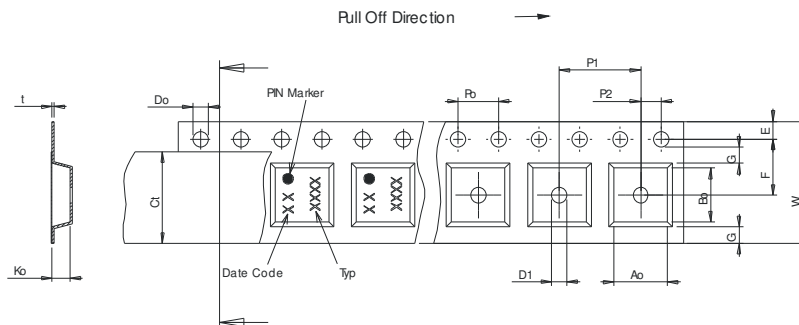

Reel (all dimensions in mm)

A	:330 or 180
W1	:8.40 +1.5/-0
W2(max)	:14.40
N(min)	:60.00
C	:13.0 ±0.2

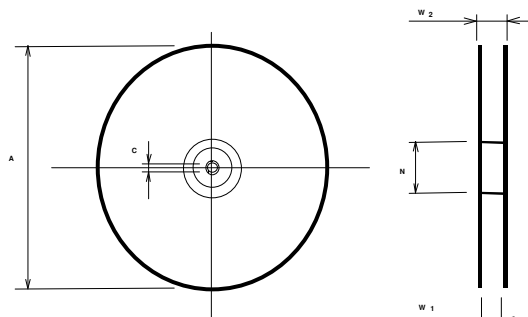

The minimum bending radius is 45 mm.

Vectron International GmbH
Potsdamer Straße 18
D 14 513 TELTOW / Germany
Tel: (+49) 3328 4784-0 / Fax: (+49) 3328 4784-30
E-Mail: tft@vectron.com

Vectron International GmbH reserves the right to make changes to the product(s) and/or information contained herein without notice. No liability is assumed as a result of their use or application. No rights under any patent accompany the sale of any such product(s) or information.

Air reflow temperature conditions

Conditions	Exposure
Average ramp-up rate (30 °C to 217 °C)	less than 3 °C / second
> 100 °C	between 300 and 600 seconds
> 150 °C	between 240 and 500 seconds
> 217 °C	between 30 and 150 seconds
Peak temperature	max. 260 °C
Time within 5 °C of actual peak temperature	between 10 and 30 seconds
Cool-down rate (Peak to 50 °C)	less than 6 °C / second
Time from 30 °C to Peak temperature	no greater than 300 seconds

Chip-mount air reflow profile

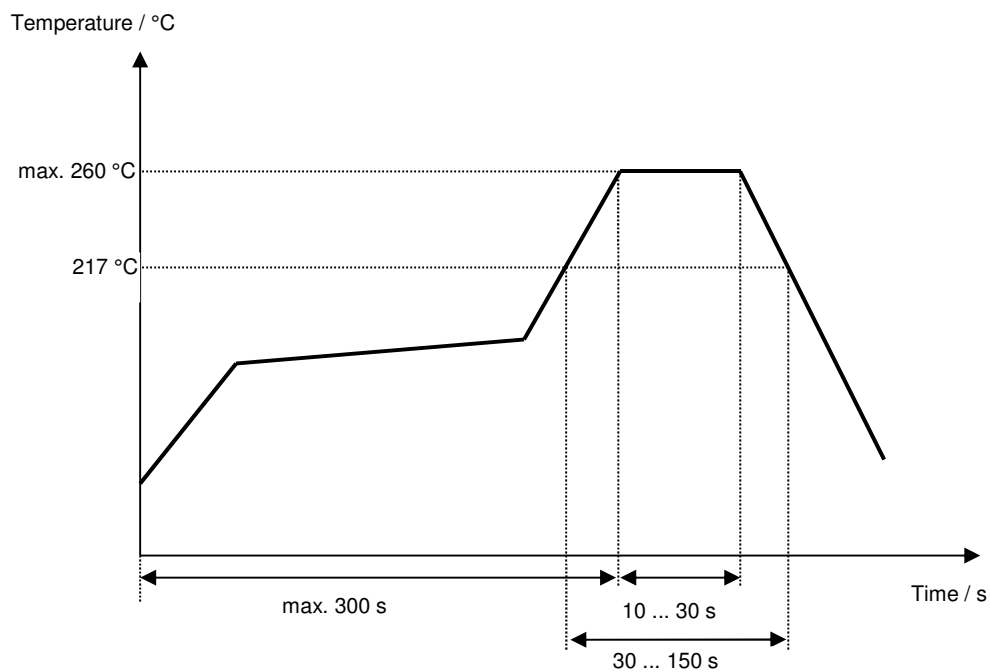

History

Version	Reason of Changes	Name	Date
1.0	- generation of filter specification	Molke	27.08.2013
1.1	- updated data table - updated stability characteristics - updated Tape & Reel	P. Jaster	05.04.2018
2.0	- updated filter characteristic - updated package	P. Jaster	11.06.2018