

Vectron International

Filter specification

TFS155D

1/5

Measurement condition

Ambient temperature T_A :	23	°C
Input power level:	0	dBm
Terminating impedance: *		
Input:	-763 Ω	-10.0 pF
Output:	-763 Ω	-10.0 pF

Characteristics

Remark:

The reference level for the relative attenuation a_{rel} of the TFS 155D is the minimum of the pass band attenuation. This value is defined as the insertion loss a_e . The nominal frequency f_N is fixed at 155 MHz without any tolerance. The values of relative attenuation a_{rel} are guaranteed for the whole operating temperature range. The frequency shift of the filter in the operating temperature range is included in the production tolerance scheme.

D a t a		typ. value	tolerance / limit
Insertion loss (reference level)	a_e	5.2 dB	max. 7 dB
Insertion loss (reference level) at 23°C	a_e	5.2 dB	max. 6 dB
Nominal frequency	f_N	-	155 MHz
Passband	PB	-	$f_N \pm 0.3$ MHz
Pass band ripple within PB		0.5 dB	max. 0.8 dB
Relative attenuation	a_{rel}		
f_N ... $f_N \pm 0.3$ MHz		0.6 dB	max. 0.8 dB
$f_N \pm 1.3$ MHz ... $f_N \pm 15$ MHz		27 dB	min. 15 dB
$f_N + 15$ MHz ... $f_N + 139.3$ MHz		43 dB	min. 40 dB
$f_N - 15$ MHz ... $f_N - 85$ MHz		51 dB	min. 40 dB
$f_N - 85$ MHz		76 dB	min. 50 dB
Group delay ripple within PB	GDR	72 ns	max. 200 ns
Return loss within PB		18	min. 10 dB
Input power		-	max. 10 dBm
Operating temperature range	OTR	-	- 40 °C ... + 85 °C
Storage temperature range		-	- 55 °C ... + 125 °C
Turnover temperature	T_0	40 °C	-
Temperature coefficient of frequency	TC_f^{**}	-0.036 ppm/K ²	-

*) The terminating impedances depend on parasitics and q-values of matching elements and the board used, and are to be understood as reference values only. Should there be additional questions do not hesitate to ask for an application note or contact our design team.

***) $\Delta f = TC_f(T - T_0)^2 f_N$

Generated:

Checked / Approved:

Vectron International GmbH
Potsdamer Straße 18
D 14 513 TELTOW / Germany
Tel: (+49) 3328 4784-0 / Fax: (+49) 3328 4784-30
E-Mail: tft@vectron.com

Vectron International GmbH reserves the right to make changes to the product(s) and/or information contained herein without notice. No liability is assumed as a result of their use or application. No rights under any patent accompany the sale of any such product(s) or information.

Filter characteristic

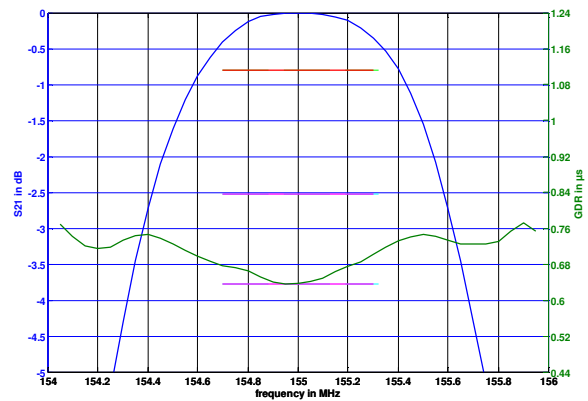
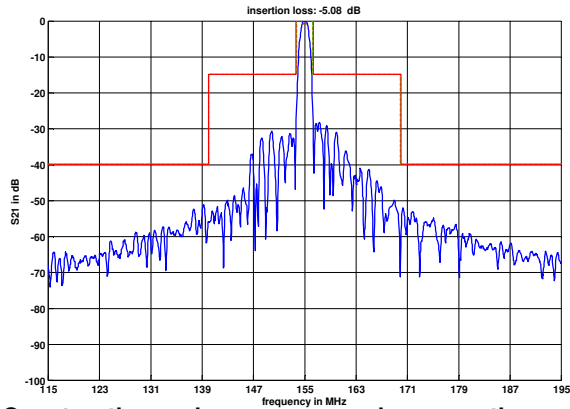

Construction and pin connection

(All dimensions in mm)

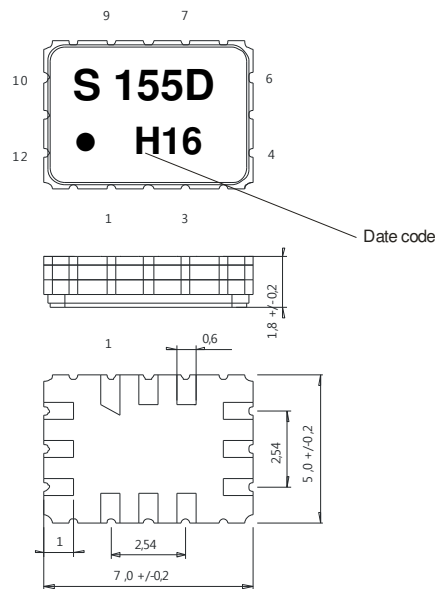

- 1 Ground
- 2 Ground
- 3 Ground
- 4 Output
- 5 Ground
- 6 Output RF Return
- 7 Ground
- 8 Ground
- 9 Ground
- 10 Input
- 11 Ground
- 12 Input RF Return

Date code: Year + week
 H 2016
 J 2017
 K 2018
 ...

50 Ohm Test circuit

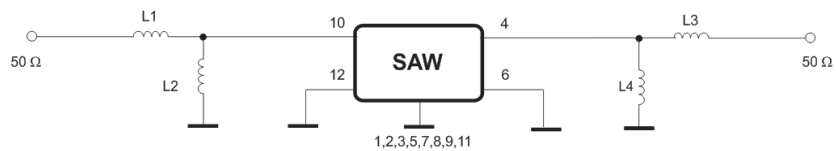

Vectron International GmbH
 Potsdamer Straße 18
 D 14 513 TELTOW / Germany
 Tel: (+49) 3328 4784-0 / Fax: (+49) 3328 4784-30
 E-Mail: tft@vectron.com

Vectron International GmbH reserves the right to make changes to the product(s) and/or information contained herein without notice. No liability is assumed as a result of their use or application. No rights under any patent accompany the sale of any such product(s) or information

Stability characteristics, reliability

After the following tests the filter shall meet the whole specification:

1. Shock: 500g, 1 ms, half sine wave, 3 shocks each plane;
DIN IEC 68 T2 - 27
2. Vibration: 10 Hz to 500 Hz, 0,35 mm or 5 g respectively, 1 octave per min, 10 cycles per plane, 3 planes;
DIN IEC 68 T2 - 6
3. Change of temperature: -55 °C to 125°C / 15 min. each / 100 cycles
DIN IEC 68 part 2 – 14 Test N
4. Resistance to solder heat (reflow): reflow possible: three times max.;
for temperature conditions refer to the attached "Air reflow temperature conditions" on page 4;
5. ESD ANSI/ESD S20.20-1999, class 1A for HBM

This filter is RoHS compliant (2011/65/EU)

Packing

Tape & Reel: IEC 286 – 3, with exception of value for N and minimum bending radius;
tape type II, embossed carrier tape with top cover tape on the upper side;

max. pieces of filters per reel: 3000
 reel of empty components at start: min. 300 mm
 reel of empty components at start including leader: min. 500 mm
 trailer: min. 300 mm

Tape (all dimensions in mm)

- W : 16.00 ± 0.3
- Po : 4.00 ± 0.1
- Do : 1.50 +0.1/-0
- E : 1.75 ± 0.1
- F : 7.50 ± 0.1
- G(min) : 0.60
- P2 : 2.00 ± 0.1
- P1 : 8.00 ± 0.1
- D1(min) : 1.50
- Ao : 5.50 ± 0.1
- Bo : 7.50 ± 0.1
- Ct : 13.5 ± 0.1

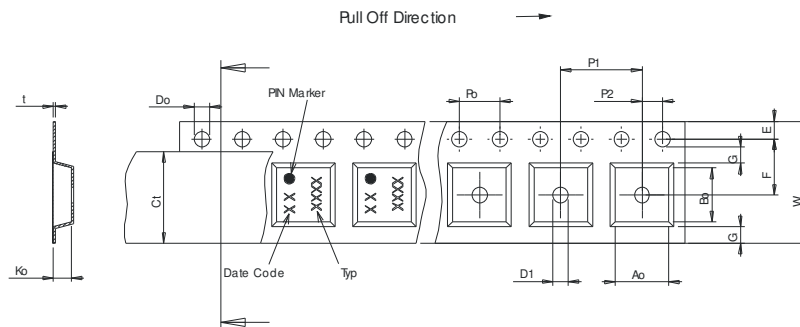

Reel (all dimensions in mm)

- A : 330
- W1 : 12.4 +2/-0
- W2(max) : 18.4
- N(min) : 50
- C : 13.0 +0.5/-0.2

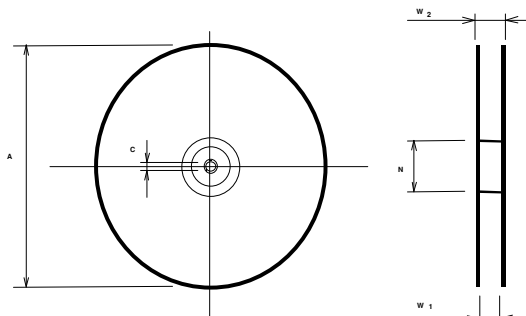

The minimum bending radius is 45 mm.

Vectron International GmbH
Potsdamer Straße 18
D 14 513 TELTOW / Germany
Tel: (+49) 3328 4784-0 / Fax: (+49) 3328 4784-30
E-Mail: tft@vectron.com

Vectron International GmbH reserves the right to make changes to the product(s) and/or information contained herein without notice. No liability is assumed as a result of their use or application. No rights under any patent accompany the sale of any such product(s) or information

Air reflow temperature conditions

Conditions	Exposure
Average ramp-up rate (30°C to 217°C)	less than 3°C/second
> 100°C	between 300 and 600 seconds
> 150°C	between 240 and 500 seconds
> 217°C	between 30 and 150 seconds
Peak temperature	max. 260°C
Time within 5°C of actual peak temperature	between 10 and 30 seconds
Cool-down rate (Peak to 50°C)	less than 6°C/second
Time from 30°C to Peak temperature	no greater than 300 seconds

Chip-mount air reflow profile

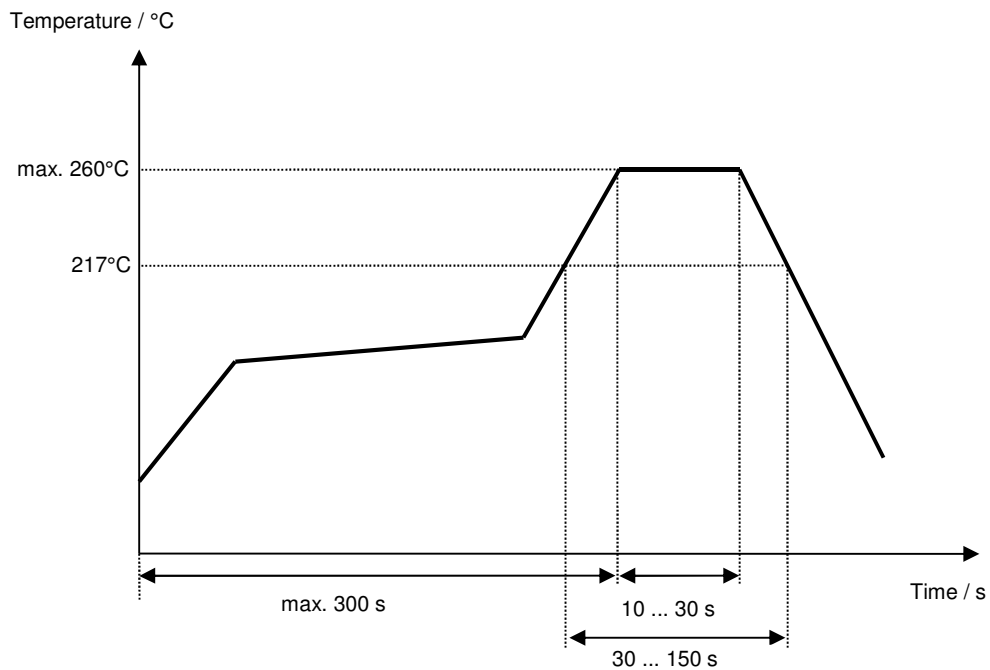

Vectron International GmbH
 Potsdamer Straße 18
 D 14 513 TELTOW / Germany
 Tel: (+49) 3328 4784-0 / Fax: (+49) 3328 4784-30
 E-Mail: tft@vectron.com

Vectron International GmbH reserves the right to make changes to the product(s) and/or information contained herein without notice. No liability is assumed as a result of their use or application. No rights under any patent accompany the sale of any such product(s) or information

History

Version	Reason of Changes	Name	Date
1.0	- Development specification	TCUK	10.03.2015
1.1	- Added Serial number to package drawing	TCUK	31.03.2015
1.2	- Changed to filter spec. Added terminating impedances, typical values & plots	TCUK	15.04.2015
1.3	- Remove serial no. as not needed for future manufacturing.	TCUK	16.05.2016