

**Vectron International****Filter specification****TFS 1575N****1/5****Measurement condition**

Ambient temperature:	23	°C
Input power level:	0	dBm
Terminating impedance:		
Input:	50	Ω
Output:	50	Ω

**Characteristics**

## Remark:

The maximum attenuation in the pass band is defined as the insertion loss  $a_e$ . The nominal frequency  $f_N$  is fixed at 1575.42 MHz without tolerance or limit. The frequency shift of the filter in the operating temperature range is included in the production tolerance scheme.

<b>D a t a</b>		<b>typ. value</b>	<b>tolerance / limit</b>	
<b>Insertion loss</b>	$a_e$	1.7	max.	2.0 dB
<b>Nominal frequency</b>	$f_N$	-		1575.42 MHz
<b>Passband</b>	PB	-	$f_N \pm$	1.2 MHz
<b>Pass band ripple</b>		0.7	max.	1.0 dB
<b>Absolute attenuation</b>	$a_{abs}$			
0.3 MHz ... 1520 MHz		43	min.	39 dB
1625 MHz ... 1630 MHz		45	min.	25 dB
1630 MHz ... 2200 MHz		47	min.	40 dB
2200 MHz ... 2400 MHz		42	min.	35 dB
2400 MHz ... 3000 MHz		35	min.	30 dB
<b>VSWR within PB</b>		1.5 : 1		2 : 1
<b>Operating temperature range</b>	OTR	-	- 40 °C ... + 85 °C	
<b>Storage temperature range</b>		-	- 45 °C ... + 85 °C	
<b>Temperature coefficient of frequency</b>	$TC_f$ *	-36 ppm/K		-

\*)  $\Delta f(\text{Hz}) = TC_f(\text{ppm/K}) \times (T - T_0) \times f_{T0}(\text{MHz})$ .

**Generated:****Checked / Approved:**

**Vectron International GmbH**  
**Potsdamer Straße 18**  
**D 14 513 TELTOW / Germany**  
**Tel: (+49) 3328 4784-0 / Fax: (+49) 3328 4784-30**  
**E-Mail: [tft@vectron.com](mailto:tft@vectron.com)**

Vectron International GmbH reserves the right to make changes to the product(s) and/or information contained herein without notice. No liability is assumed as a result of their use or application. No rights under any patent accompany the sale of any such product(s) or information.

**Filter characteristic**

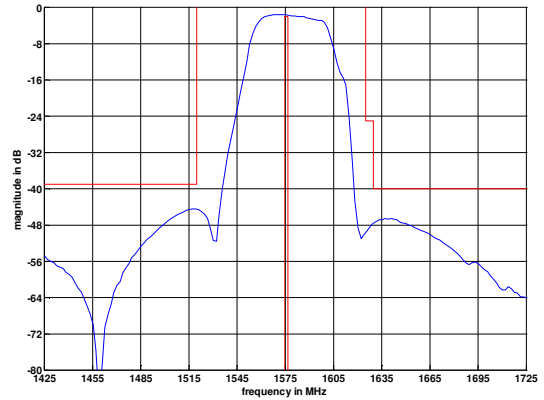
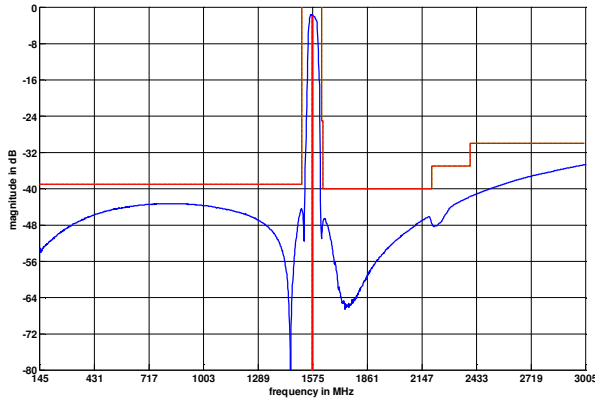

**Construction and pin connection**

(All dimensions in mm)

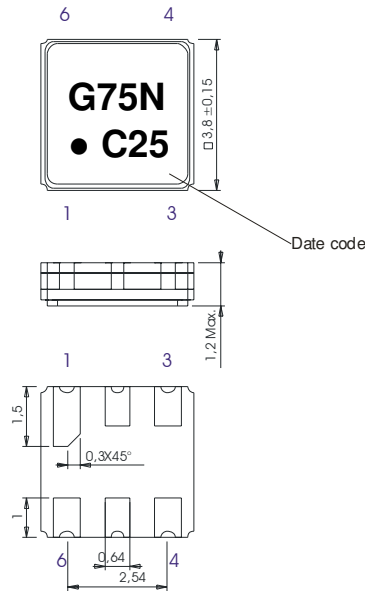

- 1 Ground
- 2 Input
- 3 Ground
- 4 Ground
- 5 Output
- 6 Ground

Date code: Year + week  
 C 2012  
 D 2013  
 E 2014  
 ...

**50 Ω Test circuit**

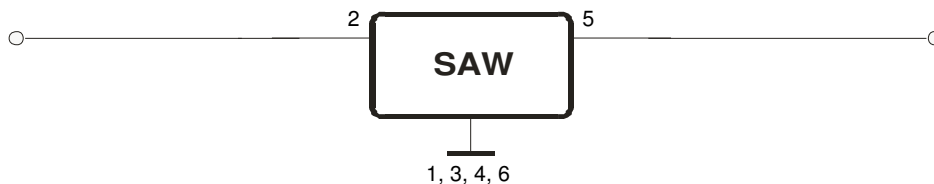

**Vectron International GmbH**  
 Potsdamer Straße 18  
 D 14 513 TELTOW / Germany  
 Tel: (+49) 3328 4784-0 / Fax: (+49) 3328 4784-30  
 E-Mail: [tft@vectron.com](mailto:tft@vectron.com)

Vectron International GmbH reserves the right to make changes to the product(s) and/or information contained herein without notice. No liability is assumed as a result of their use or application. No rights under any patent accompany the sale of any such product(s) or information.

**Stability characteristics, reliability**

After the following tests the filter shall meet the whole specification:

- 1. Shock: 500g, 1 ms, half sine wave, 3 shocks each plane;  
DIN IEC 68 T2 - 27
- 2. Vibration: 10 Hz to 500 Hz, 0,35 mm or 5 g respectively, 1 octave per min, 10 cycles per plan, 3 plans;  
DIN IEC 68 T2 - 6
- 3. Change of temperature: -55 °C to 125°C / 30 min. each / 10 cycles  
DIN IEC 68 part 2 – 14 Test N
- 4. Resistance to solder heat (reflow): reflow possible: twice max.;  
for temperature conditions refer to the attached "Air reflow temperature conditions" on page 4;

This filter is RoHS compliant (2002/95/EG, 2005/618/EG)

**Packing**

Tape & Reel: IEC 286 – 3, with exception of value for N and minimum bending radius;  
tape type II, embossed carrier tape with top cover tape on the upper side;

max. pieces of filters per reel: 3000  
reel of empty components at start: min. 300 mm  
reel of empty components at start including leader: min. 500 mm  
trailer: min. 300 mm

**Tape (all dimensions in mm)**

- W : 12,00 ± 0,3
- Po : 4,00 ± 0,1
- Do : 1,50 +0,1/-0
- E : 1,75 ± 0,1
- F : 5,50 ± 0,05
- G(min) : 0,75
- P2 : 2,00 ± 0,05
- P1 : 8,00 ± 0,1
- D1(min) : 1,50
- Ao : 4,30 ± 0,1
- Bo : 4,30 ± 0,1
- Ct : 9,5 ± 0,1

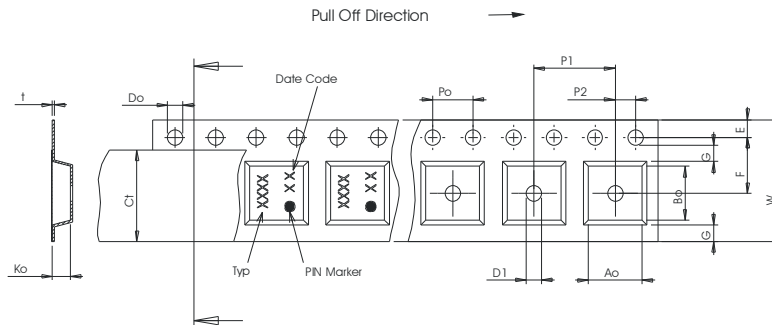

**Reel (all dimensions in mm)**

- A : 330
- W1 : 12,4 +2/-0
- W2(max) : 18,4
- N(min) : 50
- C : 13,0 +0,5/-0,2

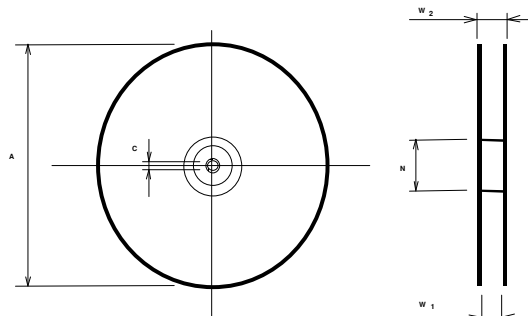

The minimum bending radius is 45 mm.

**Vectron International GmbH**  
**Potsdamer Straße 18**  
**D 14 513 TELTOW / Germany**  
**Tel: (+49) 3328 4784-0 / Fax: (+49) 3328 4784-30**  
**E-Mail: [tft@vectron.com](mailto:tft@vectron.com)**

Vectron International GmbH reserves the right to make changes to the product(s) and/or information contained herein without notice. No liability is assumed as a result of their use or application. No rights under any patent accompany the sale of any such product(s) or information.

**Air reflow temperature conditions**

<b>Conditions</b>	<b>Exposure</b>
Average ramp-up rate (30°C to 217°C)	less than 3°C/second
> 100°C	between 300 and 600 seconds
> 150°C	between 240 and 500 seconds
> 217°C	between 30 and 150 seconds
Peak temperature	max. 260°C
Time within 5°C of actual peak temperature	between 10 and 30 seconds
Cool-down rate (Peak to 50°C)	less than 6°C/second
Time from 30°C to Peak temperature	no greater than 300 seconds

**Chip-mount air reflow profile**

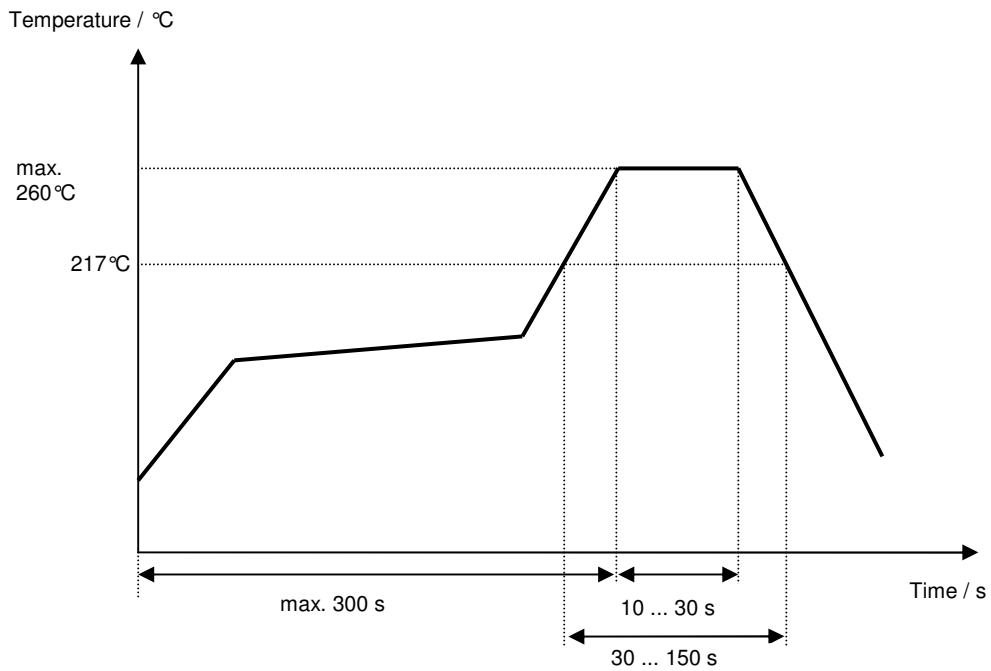

**Vectron International GmbH**  
 Potsdamer Straße 18  
 D 14 513 TELTOW / Germany  
 Tel: (+49) 3328 4784-0 / Fax: (+49) 3328 4784-30  
 E-Mail: [tft@vectron.com](mailto:tft@vectron.com)

Vectron International GmbH reserves the right to make changes to the product(s) and/or information contained herein without notice. No liability is assumed as a result of their use or application. No rights under any patent accompany the sale of any such product(s) or information.

**History**

<b>Version</b>	<b>Reason of Changes</b>	<b>Name</b>	<b>Date</b>
1.0	- Generation of preliminary specification	Strehl	02.03.2006
1.1	- Change absolute attenuation	Strehl	24.03.2006
1.2	- Change construction	Strehl	19.04.2006
1.3	- Added filter characteristic, added typical values to data sheet	Schönbein	22.06.2012