

**Measurement condition**

Ambient temperature:	23	°C
Input power level:	0	dBm
Terminating impedance:		
Input:	50	Ω
Output:	50	Ω

**Characteristics**

**Remark:**

The maximum attenuation in the passband is defined as the insertion loss  $a_e$ . The nominal frequency  $f_N$  is fixed at 1581.5 MHz without any tolerance or limit. The values of absolute attenuation  $a_{abs}$  are guaranteed for the whole operating temperature range. The frequency shift of the filter in the operating temperature range is included in the production tolerance scheme.

<b>D a t a</b>		<b>typ. value</b>		<b>tolerance / limit</b>	
<b>Insertion loss in PB</b>		$a_e$	4.0 dB	max.	5.0 dB
<b>Nominal frequency</b>		$f_N$	-		1581.5 MHz
<b>Passband</b>		PB	-		$f_N \pm 28.5$ MHz
<b>Passband variation</b>			0.7 dB	max.	3.0 dB
<b>Absolute attenuation</b>		$a_{abs}$			
0.3 MHz ... 1485 MHz			40 dB	min.	30 dB
1485 MHz ... 1510 MHz			16 dB	min.	7 dB
1665 MHz ... 1685 MHz			28 dB	min.	10 dB
1685 MHz ... 3000 MHz			39 dB	min.	30 dB
<b>Group delay ripple</b>					
1553 MHz ... 1585 MHz			4 ns	max.	10 ns
1593 MHz ... 1610 MHz			4 ns	max.	10 ns
<b>Return loss within PB</b>			9.5 dB	min.	7 dB
<b>Input power level in PB</b>			-	max.	10 dBm
<b>Operating temperature range</b>		OTR	-		- 40 °C ... + 85 °C
<b>Storage temperature range</b>			-		- 40 °C ... + 85 °C
<b>Temperature coefficient of frequency</b>		$TC_f$ *	-76 ppm/K		

\*)  $\Delta f_c(\text{Hz}) = TC_f(\text{ppm/K}) \times (T - T_0) \times f_{CAT}(\text{MHz})$

**Generated:**

---

**Checked / Approved:**

---

**Vectron International GmbH**  
**Potsdamer Straße 18**  
**D 14 513 TELTOW / Germany**  
**Tel: (+49) 3328 4784-0 / Fax: (+49) 3328 4784-30**  
**E-Mail: [tft@vectron.com](mailto:tft@vectron.com)**

Vectron International GmbH reserves the right to make changes to the product(s) and/or information contained herein without notice. No liability is assumed as a result of their use or application. No rights under any patent accompany the sale of any such product(s) or information.

**Filter characteristic**

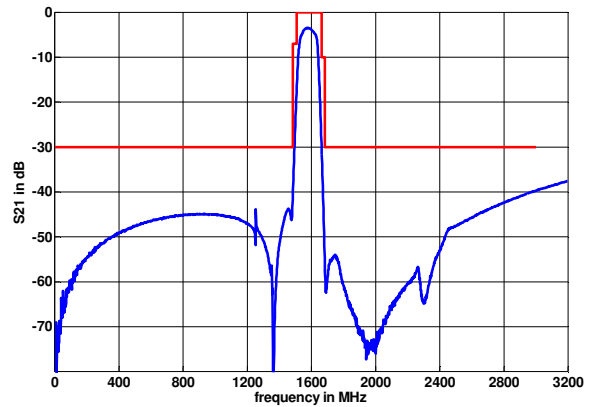
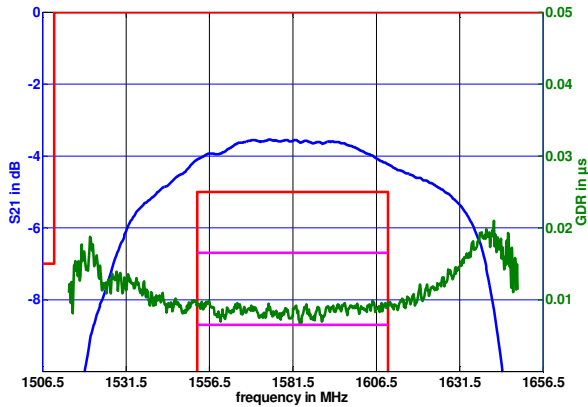

**Construction and pin connection**

(All dimensions in mm)

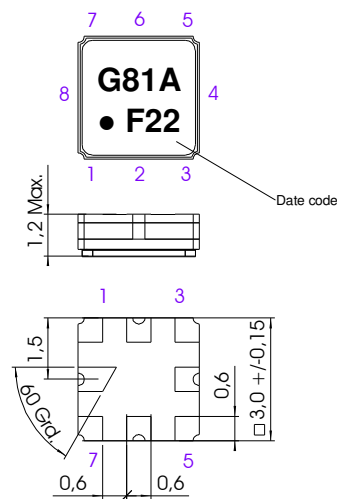

- 1 Ground
- 2 Input
- 3 Ground
- 4 Ground
- 5 Ground
- 6 Output
- 7 Ground
- 8 Ground

Date code: Year + week  
 F 2015  
 G 2016  
 H 2017  
 ...

**50 Ω Test circuit**

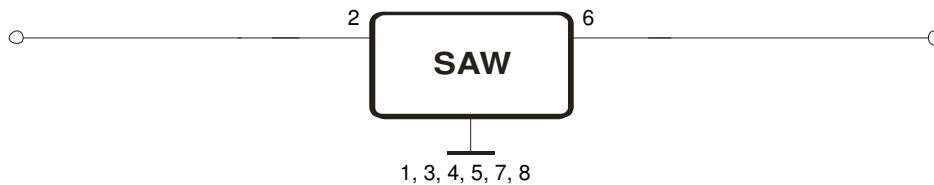

**Vectron International GmbH**  
 Potsdamer Straße 18  
 D 14 513 TELTOW / Germany  
 Tel: (+49) 3328 4784-0 / Fax: (+49) 3328 4784-30  
 E-Mail: [tft@vectron.com](mailto:tft@vectron.com)

Vectron International GmbH reserves the right to make changes to the product(s) and/or information contained herein without notice. No liability is assumed as a result of their use or application. No rights under any patent accompany the sale of any such product(s) or information.

**Stability characteristics, reliability**

After the following tests the filter shall meet the whole specification:

1. Shock: 500g, 1 ms, half sine wave, 3 shocks each plane;  
DIN IEC 68 T2 - 27
2. Vibration: 10 Hz to 500 Hz, 0,35 mm or 5 g respectively, 1 octave per min, 10 cycles per plane, 3 planes; DIN IEC 68 T2 - 6
3. Change of temperature: -55 °C to 125°C / 15 min. each / 100 cycles  
DIN IEC 68 part 2 – 14 Test N
4. Resistance to solder heat (reflow): reflow possible: three times max.;  
for temperature conditions, see page 4: "Air reflow temperature conditions"

This filter is RoHS compliant (2011/65/EU)

**Packing**

Tape & Reel: IEC 286 – 3, with exception of value for N and minimum bending radius;  
tape type II, embossed carrier tape with top cover tape on the upper side;

max. pieces of filters per reel:	3000
reel of empty components at start:	min. 300 mm
reel of empty components at start including leader:	min. 500 mm
trailer:	min. 300 mm

**Tape (all dimensions in mm)**

- W : 8,00 ± 0,3
- Po : 4,00 ± 0,1
- Do : 1,50 +0,1/-0
- E : 1,75 ± 0,1
- F : 3,50 ± 0,05
- G(min) : 0,75
- P2 : 2,00 ± 0,05
- P1 : 4,00 ± 0,1
- D1(min) : 1,50
- Ao : 3,25 ± 0,1
- Bo : 3,25 ± 0,1
- Ct : 5,3 ± 0,1

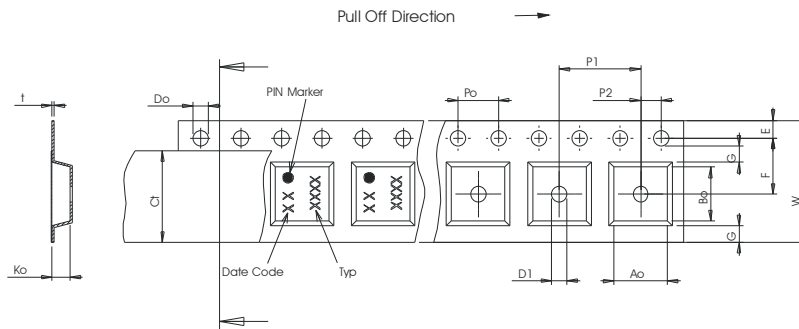

**Reel (all dimensions in mm)**

- A : 330 or 180
- W1 : 8,4 +1,5/-0
- W2(max) : 14,4
- N(min) : 60
- C : 13,0 ± 0,2

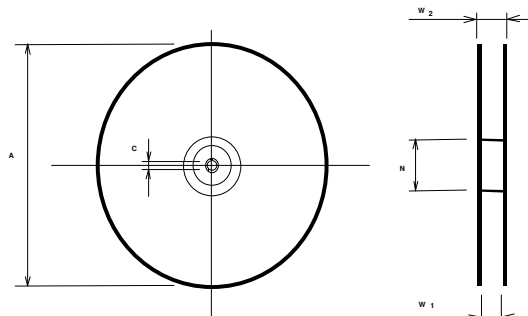

The minimum bending radius is 45 mm.

**Vectron International GmbH**  
**Potsdamer Straße 18**  
**D 14 513 TELTOW / Germany**  
**Tel: (+49) 3328 4784-0 / Fax: (+49) 3328 4784-30**  
**E-Mail: [tft@vectron.com](mailto:tft@vectron.com)**

Vectron International GmbH reserves the right to make changes to the product(s) and/or information contained herein without notice. No liability is assumed as a result of their use or application. No rights under any patent accompany the sale of any such product(s) or information.

**Air reflow temperature conditions**

Conditions	Exposure
Average ramp-up rate (30°C to 217°C)	less than 3°C/second
> 100°C	between 300 and 600 seconds
> 150°C	between 240 and 500 seconds
> 217°C	between 30 and 150 seconds
Peak temperature	max. 260°C
Time within 5°C of actual peak temperature	between 10 and 30 seconds
Cool-down rate (Peak to 50°C)	less than 6°C/second
Time from 30°C to Peak temperature	no greater than 300 seconds

**Chip-mount air reflow profile**

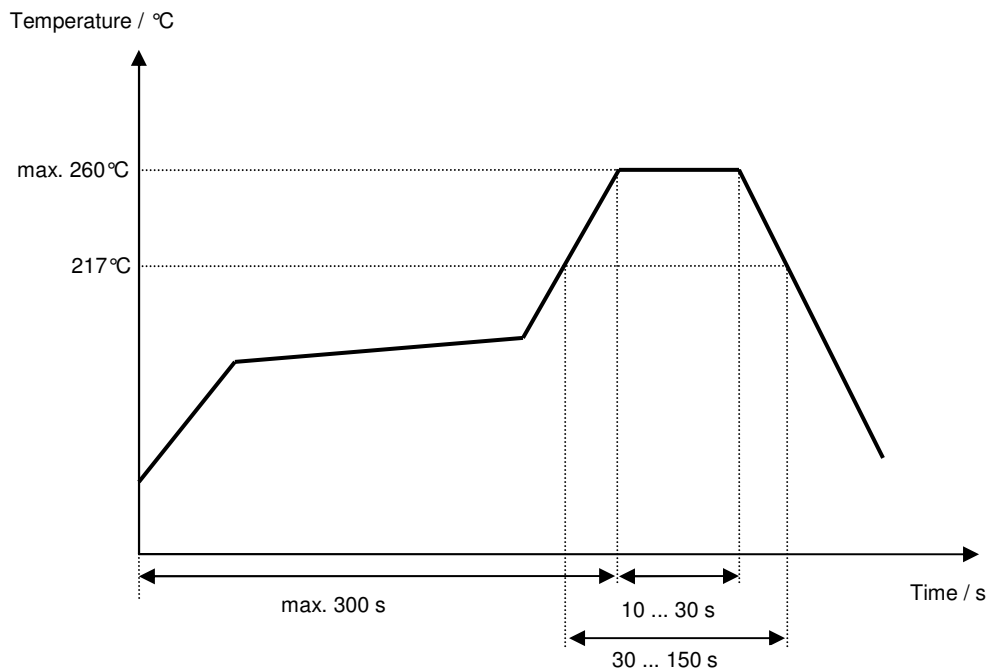

**Vectron International GmbH**  
 Potsdamer Straße 18  
 D 14 513 TELTOW / Germany  
 Tel: (+49) 3328 4784-0 / Fax: (+49) 3328 4784-30  
 E-Mail: [tft@vectron.com](mailto:tft@vectron.com)

Vectron International GmbH reserves the right to make changes to the product(s) and/or information contained herein without notice. No liability is assumed as a result of their use or application. No rights under any patent accompany the sale of any such product(s) or information.

**History**

<b>Version</b>	<b>Reason of Changes</b>	<b>Name</b>	<b>Date</b>
1.0	- Generation of development specification	A. Molke	25.09.2014
1.1	- Change from development spec to filter spec - Typical values added - Filter characteristic added	A. Molke	27.05.2015