

Vectron International**Filter specification****TFS 500C****1/5****Measurement condition**

Ambient temperature:	23	°C
Input power level:	0	dBm
Terminating impedance: *		
Input:	415 Ω -1 pF	
Output:	415 Ω -1 pF	
External Coil:	33 nH	

Characteristics

Remark:

The reference level for the relative attenuation a_{rel} of the TFS500C is the minimum of the pass band attenuation. This value is defined as the insertion loss a_e . The nominal frequency f_N is fixed at 500.0 MHz without any tolerance. The values of relative attenuation a_{rel} are guaranteed for the whole operating temperature range. The frequency shift of the filter in the operating temperature range is included in the production tolerance scheme.

D a t a		typ. value		tolerance / limit	
Insertion loss (reference level)	a_e	4.0	dB	max.	5.0 dB
Nominal frequency	f_N				500.0 MHz
Passband	PB	390	kHz	$f_N \pm$	0.1 MHz
Pass band variation		1.3	dB	max.	2.0 dB
Relative attenuation	a_{rel}				
$f_N - 100$ MHz ... $f_N - 90$ MHz		48	dB	min.	40 dB
$f_N - 90$ MHz ... $f_N - 60$ MHz		42	dB	min.	38 dB
$f_N - 60$ MHz ... $f_N - 1$ MHz		47	dB	min.	40 dB
$f_N + 1$ MHz ... $f_N + 100$ MHz		42	dB	min.	40 dB
Input power level		-		max.	10 dBm
Operating temperature range	OTR	-			- 40 °C ... + 85°C
Storage temperature range		-			- 55 °C ... + 125°C
Frequency inversion temperature	T_0	18	°C		
Temperature coefficient of frequency	TC_f **	- 0.036	ppm/K ²		

*) The terminating impedances depend on parasitics and q-values of matching elements and the board used, and are to be understood as reference values only. Should there be additional questions do not hesitate to ask for an application note or contact our design team.

**) $\Delta f = TC_f (T - T_0)^2 f_N$

Generated:**Checked / Approved:**

Vectron International GmbH
Potsdamer Straße 18
D 14 513 TELTOW / Germany
Tel: (+49) 3328 4784-0 / Fax: (+49) 3328 4784-30
E-Mail: tft@vectron.com

Vectron International GmbH reserves the right to make changes to the product(s) and/or information contained herein without notice. No liability is assumed as a result of their use or application. No rights under any patent accompany the sale of any such product(s) or information.

Filter characteristic

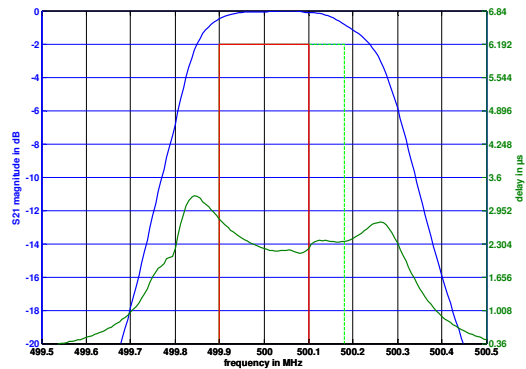
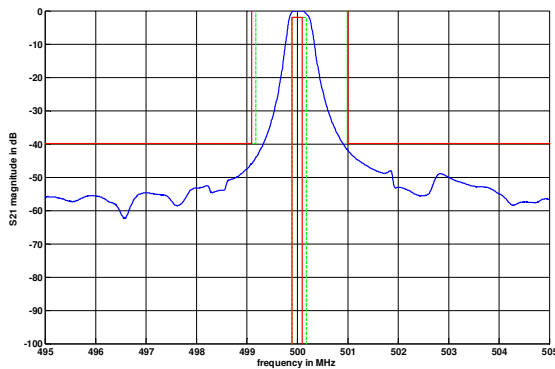

Construction and pin connection

(All dimensions in mm)

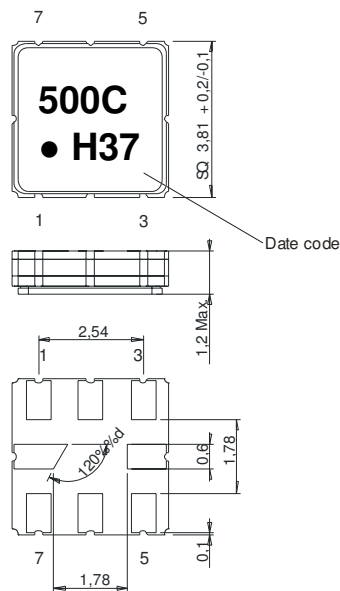

- 1 Input
- 2 Input RF Return
- 3 External Coil
- 4 Ground
- 5 Output
- 6 Output RF Return
- 7 Ground
- 8 Ground

Date code: Year + week
 H 2016
 J 2017
 K 2018
 ...

50 Ω Test circuit

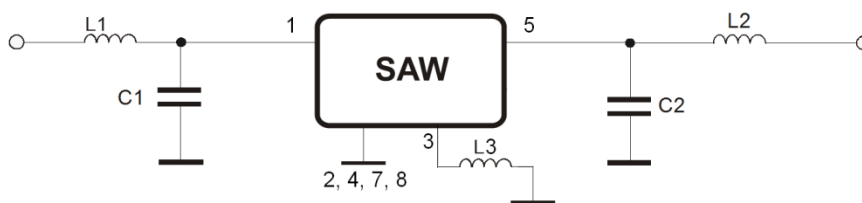

Vectron International GmbH
 Potsdamer Straße 18
 D 14 513 TELTOW / Germany
 Tel: (+49) 3328 4784-0 / Fax: (+49) 3328 4784-30
 E-Mail: tft@vectron.com

Vectron International GmbH reserves the right to make changes to the product(s) and/or information contained herein without notice. No liability is assumed as a result of their use or application. No rights under any patent accompany the sale of any such product(s) or information.

Stability characteristics, reliability

After the following tests the filter shall meet the whole specification:

1. Shock: 500 g, 1 ms, half sine wave, 3 shocks each plane;
DIN IEC 60068 T2 - 27
2. Vibration: 10 Hz to 2000 Hz, 0.35 mm or <VIBRATIONACCEL> g respectively, 1 octave per min, 10 cycles per plane, 3 planes; DIN IEC 60068 T2 - 6
3. Change of temperature: -55 °C to 125 °C / 15 min. each / 100 cycles
DIN IEC 60068 part 2 – 14 Test N
4. Resistance to solder heat (reflow): reflow possible: three times max.;
for temperature conditions, see page 4: "Air reflow temperature conditions"

5. SAW devices are Electrostatic Discharge (ESD) sensitive devices.

ESD SIMULATION MODEL	CLASSIFICATION LEVEL	CRITERIA
Human Body Model (HBM) acc. to ANSI/ESDA/JEDEC JS-001-2014	Class 1A	1 positive + 1 negative pulse 250 ... 500 Volts

This filter is RoHS compliant (2011/65/EU)

Packing

- Tape & Reel: IEC 286 – 3, with exception of value for N and minimum bending radius;
tape type II, embossed carrier tape with top cover tape on the upper side;
- max. pieces of filters per reel: 3000
reel of empty components at start: min. 300 mm
reel of empty components at start including leader: min. 500 mm
trailer: min. 300 mm

Tape (all dimensions in mm)

- W : 12.00 ± 0.3
- Po : 4.00 ± 0.1
- Do : 1.50 +0.1/-0
- E : 1.75 ± 0.1
- F : 5.50 ± 0.05
- G(min) : 0.75
- P2 : 2.00 ± 0.05
- P1 : 8.00 ± 0.1
- D1(min) : 1.50
- Ao : 4.30 ± 0.1
- Bo : 4.30 ± 0.1
- Ct : 9.2 ± 0.1

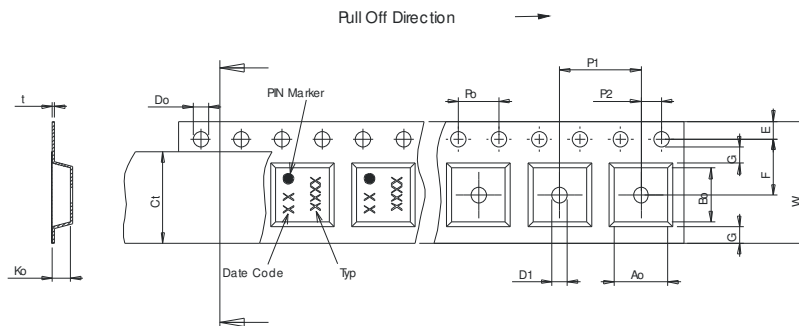

Reel (all dimensions in mm)

- A : 330 or 180
- W1 : 12.4 +2/-0
- W2(max) : 18.4
- N(min) : 50
- C : 13.0 +0.5/-0.2

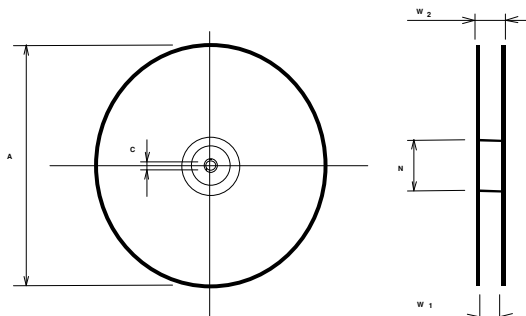

The minimum bending radius is 45 mm.

Vectron International GmbH
Potsdamer Straße 18
D 14 513 TELTOW / Germany
Tel: (+49) 3328 4784-0 / Fax: (+49) 3328 4784-30
E-Mail: tft@vectron.com

Vectron International GmbH reserves the right to make changes to the product(s) and/or information contained herein without notice. No liability is assumed as a result of their use or application. No rights under any patent accompany the sale of any such product(s) or information.

Air reflow temperature conditions

Conditions	Exposure
Average ramp-up rate (30°C to 217°C)	less than 3°C/second
> 100°C	between 300 and 600 seconds
> 150°C	between 240 and 500 seconds
> 217°C	between 30 and 150 seconds
Peak temperature	max. 260°C
Time within 5°C of actual peak temperature	between 10 and 30 seconds
Cool-down rate (Peak to 50°C)	less than 6°C/second
Time from 30°C to Peak temperature	no greater than 300 seconds

Chip-mount air reflow profile

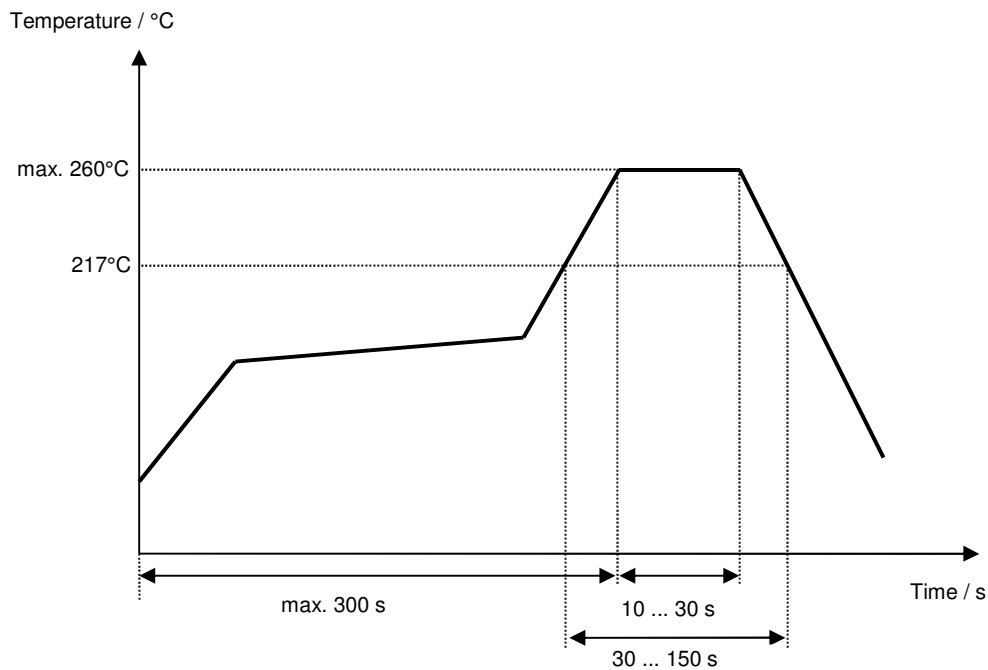

Vectron International GmbH
 Potsdamer Straße 18
 D 14 513 TELTOW / Germany
 Tel: (+49) 3328 4784-0 / Fax: (+49) 3328 4784-30
 E-Mail: tft@vectron.com

Vectron International GmbH reserves the right to make changes to the product(s) and/or information contained herein without notice. No liability is assumed as a result of their use or application. No rights under any patent accompany the sale of any such product(s) or information.

History

Version	Reason of Changes	Name	Date
1.0	- Generation of development specification	Bonnen	17.06.2014
2.0	- Change to Filter specification - Change frequency inversion temperature	Bonnen	29.07.2014
2.1	- Change storage temperature range	Bonnen	30.08.2016
2.2	- Change Date code: Year + week	Bonnen	14.09.2016