

Vectron International

Filter specification

TFS 92F

1/5

Measurement condition

Ambient temperature: 23 °C
 Input power level: 0 dBm
 Terminating impedance: *
 Input: 1320 Ω || - 10.7 pF
 Output: 1433 Ω || - 9.8 pF

Characteristics

Remark:

The reference level for the relative attenuation a_{rel} of the TFS92F is the minimum of the pass band attenuation. This value is defined as the insertion loss a_e . The nominal frequency f_N is fixed at 92MHz without any tolerance. The values of relative attenuation a_{rel} are guaranteed for the whole operating temperature range. The frequency shift of the filter in the operating temperature range is included in the production tolerance scheme.

D a t a		typ. value		tolerance / limit	
Insertion loss (reference level)		a_e	6.1 dB	max.	8 dB
Nominal frequency		f_N	-	92.0	MHz
Passband		PB	-	$f_N \pm 0.08$	MHz
Pass band ripple within PB			0.24 dB	max.	1.5 dB
Relative attenuation		a_{rel}			
f_N	MHz ... $f_N \pm 0.08$ MHz		0.24 dB	max.	1.5 dB
$f_N \pm 0.4$	MHz ... $f_N \pm 0.6$ MHz		30 dB	min.	25 dB
$f_N \pm 0.6$	MHz ... $f_N \pm 1.0$ MHz		39 dB	min.	35 dB
$f_N \pm 1.0$	MHz ... $f_N \pm 40.0$ MHz		42 dB	min.	40 dB
Average group delay within PB			2.5 μs	max.	5.0 μs
Group delay ripple within PB		p-p	600 ns	max.	1000 ns
Input/output return loss within PB			20	min.	10 dB
Operating temperature range		OTR	-	- 40 °C ... + 85 °C	
Storage temperature range			-	- 40 °C ... + 85 °C	
Temperature coefficient of frequency		TC_f	-0.036 ppm/K ²	-	

*) The terminating impedances depend on parasitics and q-values of matching elements and the board used, and are to be understood as reference values only. Should there be additional questions do not hesitate to ask for an application note or contact our design team.

Generated: _____

Checked / Approved: _____

Vectron International GmbH
 Potsdamer Straße 18
 D 14 513 TELTOW / Germany
 Tel: (+49) 3328 4784-0 / Fax: (+49) 3328 4784-30
 E-Mail: tft@vectron.com

Vectron International GmbH reserves the right to make changes to the product(s) and/or information contained herein without notice. No liability is assumed as a result of their use or application. No rights under any patent accompany the sale of any such product(s) or information.

Filter characteristic

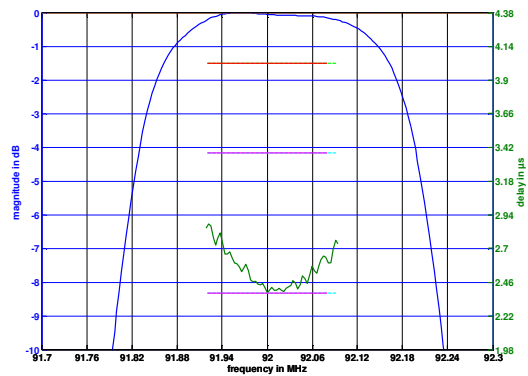
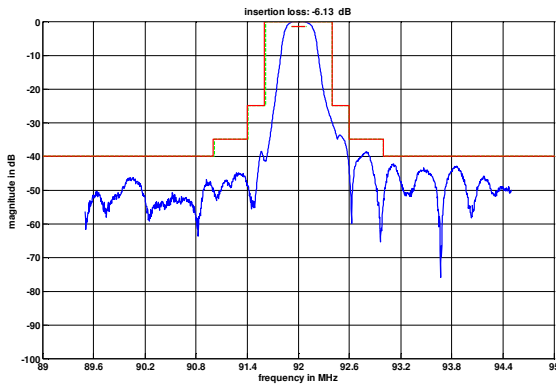

Construction and pin connection

(All dimensions in mm)

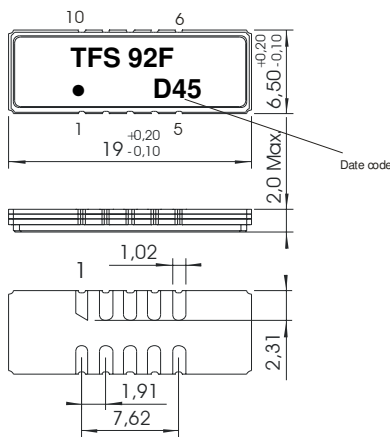

- 1 Input
- 2 Ground
- 3 Ground
- 4 Ground
- 5 Output RF Return (Ground)
- 6 Output
- 7 Ground
- 8 Ground
- 9 Ground
- 10 Input RF Return (Ground)

Date code: Year + week
 D 2013
 E 2014
 F 2015
 ...

50 Ω Test circuit

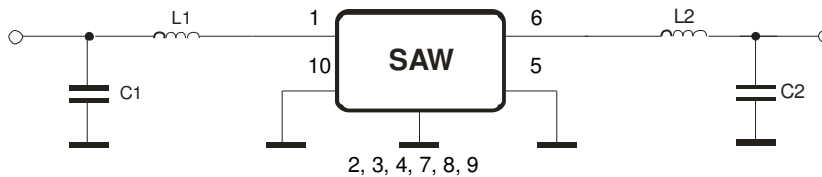

Vectron International GmbH
 Potsdamer Straße 18
 D 14 513 TELTOW / Germany
 Tel: (+49) 3328 4784-0 / Fax: (+49) 3328 4784-30
 E-Mail: tft@vectron.com

Vectron International GmbH reserves the right to make changes to the product(s) and/or information contained herein without notice. No liability is assumed as a result of their use or application. No rights under any patent accompany the sale of any such product(s) or information.

Stability characteristics, reliability

After the following tests the filter shall meet the whole specification:

1. Shock: 500g, 1 ms, half sine wave, 3 shocks each plane;
DIN IEC 68 T2 - 27
2. Vibration: 10 Hz to 500 Hz, 0,35 mm or g respectively, 1 octave per min, 10 cycles per plane, 3 planes;
DIN IEC 68 T2 - 6
3. Change of temperature: -55 °C to 125°C / 15 min. each / 100 cycles
DIN IEC 68 part 2 – 14 Test N
4. Resistance to solder heat (reflow): reflow possible: three times max.;
for temperature conditions, see page 4: "Air reflow temperature conditions"
5. ESD ANSI/ESD S20.20-1999, class 1A for HBM

This filter is RoHS compliant (2011/65/EU)

Packing

Tape & Reel: IEC 286 – 3, with exception of value for N and minimum bending radius;
tape type II, embossed carrier tape with top cover tape on the upper side;

max. pieces of filters per reel:	2000
reel of empty components at start:	min. 300 mm
reel of empty components at start including leader:	min. 500 mm
trailer:	min. 300 mm

Tape (all dimensions in mm)

- W : 32,00 ± 0,3
- Po : 4,00 ± 0,1
- Do : 1,50 +0,1/-0
- E : 1,75 ± 0,1
- F : 14,20 ± 0,1
- G(min) :
- P2 : 2,00 ± 0,1
- P1 : 12,00 ± 0,1
- D1(min) : 2,00
- Ao : 7,10 ± 0,1
- Bo : 19,60 ± 0,1
- Ct : 25,5 ± 0,1

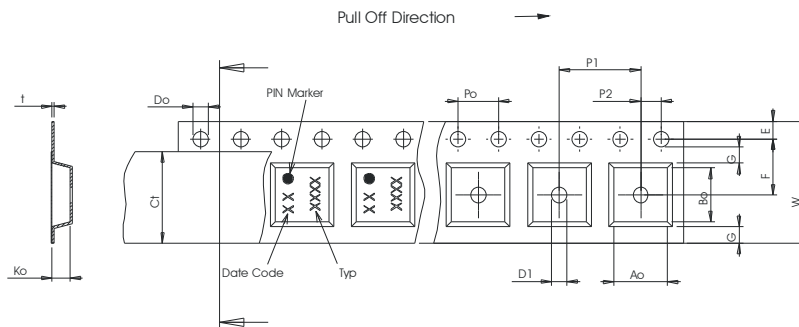

Reel (all dimensions in mm)

- A : 330
- W1 : 32,4 +2/-0
- W2(max) : 38,4
- N(min) : 100
- C : 13,0 +0,5/-0,2

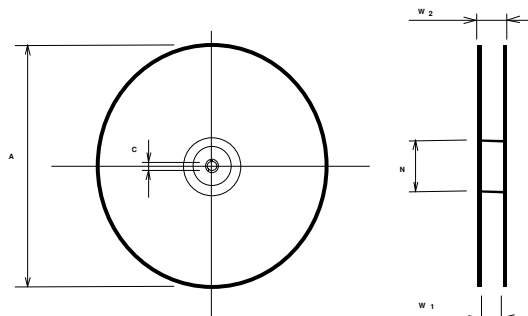

The minimum bending radius is 45 mm.

Vectron International GmbH
Potsdamer Straße 18
D 14 513 TELTOW / Germany
Tel: (+49) 3328 4784-0 / Fax: (+49) 3328 4784-30
E-Mail: tft@vectron.com

Vectron International GmbH reserves the right to make changes to the product(s) and/or information contained herein without notice. No liability is assumed as a result of their use or application. No rights under any patent accompany the sale of any such product(s) or information.

Air reflow temperature conditions

Conditions	Exposure
Average ramp-up rate (30°C to 217°C)	less than 3°C/second
> 100°C	between 300 and 600 seconds
> 150°C	between 240 and 500 seconds
> 217°C	between 30 and 150 seconds
Peak temperature	max. 260°C
Time within 5°C of actual peak temperature	between 10 and 30 seconds
Cool-down rate (Peak to 50°C)	less than 6°C/second
Time from 30°C to Peak temperature	no greater than 300 seconds

Chip-mount air reflow profile

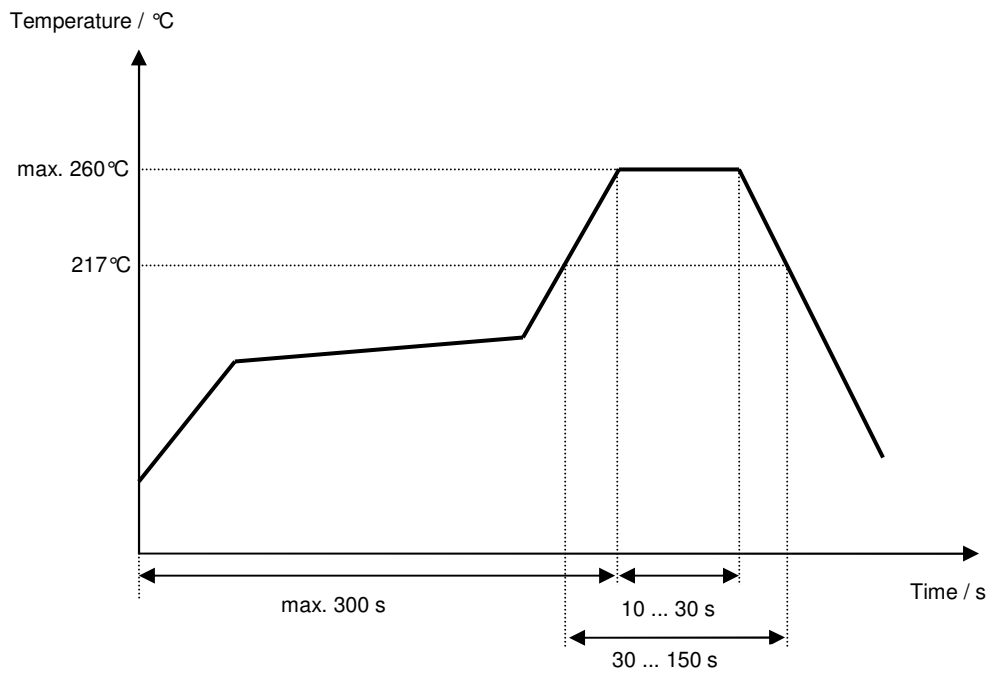

Vectron International GmbH
 Potsdamer Straße 18
 D 14 513 TELTOW / Germany
 Tel: (+49) 3328 4784-0 / Fax: (+49) 3328 4784-30
 E-Mail: tft@vectron.com

Vectron International GmbH reserves the right to make changes to the product(s) and/or information contained herein without notice. No liability is assumed as a result of their use or application. No rights under any patent accompany the sale of any such product(s) or information.

History

Version	Reason of Changes	Name	Date
1.0	Generation of development specification	TCUK	05.04.2013
1.1	Add typ values and move from development to filter specification	TCUK	09.08.2013