

Vectron International**Filter specification****TFS 400S****1/5****Measurement condition**

Ambient temperature:	23	°C
Input power level:	0	dBm
Terminating impedance: *		
Input:	570 Ω -1,2 pF	
Output:	570 Ω -1,2 pF	
External Coil:	97 nH	

Characteristics

Remark:

Reference level for the relative attenuation a_{rel} of the TFS 400 S is the minimum of the pass band attenuation a_{min} . The minimum of the pass band attenuation a_{min} is defined as the insertion loss a_e . The centre frequency f_C is the arithmetic mean value of the upper and lower frequencies at the 3 dB filter attenuation level relative to the insertion loss a_e . The nominal frequency f_N is fixed at 400 MHz without tolerance. The given values for the relative attenuation a_{rel} and for the group delay ripple have to be reached at the frequencies given below even if the centre frequency f_C is shifted due to the temperature coefficient of frequency TC_f in the operating temperature range and due to a production tolerance for the centre frequency f_C .

D a t a		typ. value	tolerance/limit
Insertion loss (Reference level)	$a_e = a_{min}$	4,5 dB	max. 6,5 dB
Nominal frequency	f_N	-	400,000 MHz
Centre frequency	f_C	400,008 MHz	
Guaranteed 1,5 dB signal band width	BW	270 kHz	min. 160 kHz
Relative attenuation $f_N \pm 80$ kHz	a_{rel}	0,5 dB	max. 1,5 dB
$f_N \pm 200$ kHz ... $f_N \pm 400$ kHz		5 dB	min. 2 dB
$f_N \pm 400$ kHz ... $f_N \pm 600$ kHz		30 dB	min. 25 dB
$f_N \pm 600$ kHz ... $f_N \pm 1$ MHz		50...70 dB	min. 40 dB
$f_N - 1$ MHz ... $f_N - 13$ MHz		57 dB	min. 50 dB
$f_N + 1$ MHz ... $f_N + 2$ MHz		65 dB	min. 50 dB
$f_N + 2$ MHz ... $f_N + 5$ MHz		53 dB	min. 47 dB
$f_N \pm 5$ MHz ... $f_N \pm 13$ MHz		56 dB	min. 50 dB
Group delay ripple $f_N \pm 70$ kHz	GD	0,5 μs	max. 2 μs
Input power level		-	max. 0 dBm
Operating temperature range			- 10 °C ... + 55 °C
Temperature coefficient of frequency	TC_f^{**}	ca. - 0,036 ppm/K ²	
Frequency inversion temperature		+ 20 °C	

*) The terminating impedances depend on parasitics and q-values of matching elements and the board used, and are to be understood as reference values only. Should there be additional questions do not hesitate to ask for an application note or contact our design team.

***) $\Delta f(\text{Hz}) = TC_f(\text{ppm/K}^2) \times (\Delta T)^2 \times f_{T0}(\text{MHz})$

Generated:**Checked / Approved:**

Vectron International GmbH & Co. KG
Potsdamer Straße 18
D 14 513 TELTOW / Germany
Tel: (+49) 3328 4784-0 / Fax: (+49) 3328 4784-30
E-Mail: tft@vectron.com

Vectron International GmbH & Co. KG reserves the right to make changes to the product(s) and/or information contained herein without notice. No liability is assumed as a result of their use or application. No rights under any patent accompany the sale of any such product(s) or information.

Filter characteristic

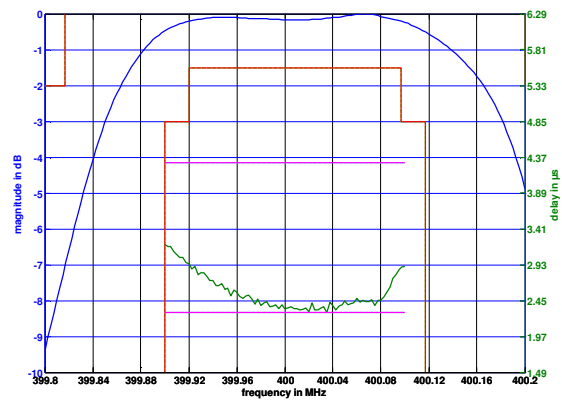
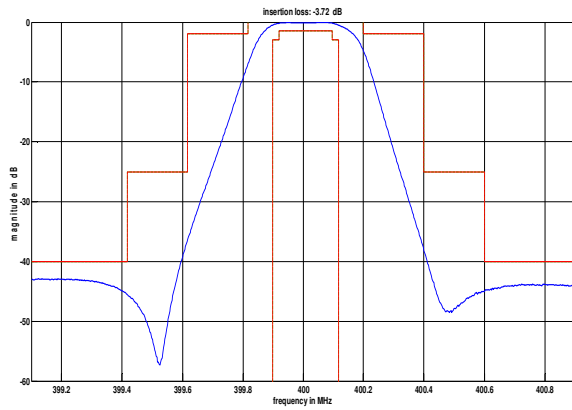

Construction and pin connection

(All dimensions in mm)

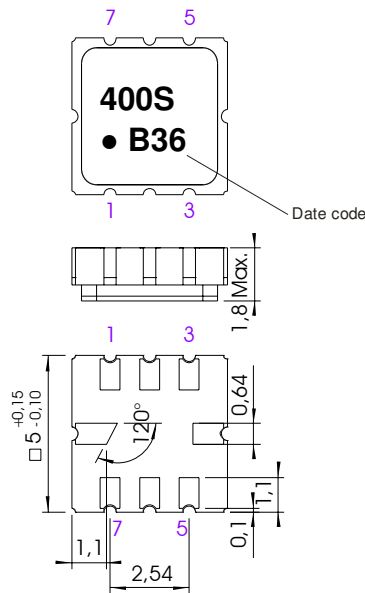

- 1 Output
- 2 Output RF Return
- 3 External Coil
- 4 Ground
- 5 Input
- 6 Input RF Return
- 7 Ground
- 8 Ground

Date code: Year + week
 B 2011
 C 2012
 D 2013
 ...

Construction, pin configuration an

(All dimensions in mm)

50 Ω Test circuit

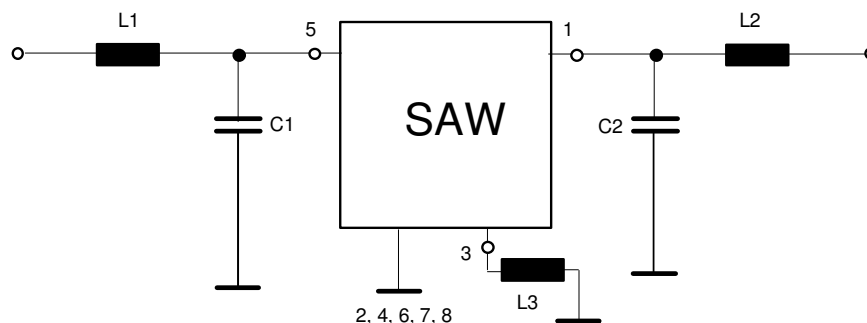

Vectron International GmbH & Co. KG
 Potsdamer Straße 18
 D 14 513 TELTOW / Germany
 Tel: (+49) 3328 4784-0 / Fax: (+49) 3328 4784-30
 E-Mail: tft@vectron.com

Vectron International GmbH & Co. KG reserves the right to make changes to the product(s) and/or information contained herein without notice. No liability is assumed as a result of their use or application. No rights under any patent accompany the sale of any such product(s) or information.

Stability characteristics, reliability

After the following tests the filter shall meet the whole specification:

1. Shock: 500g, 1 ms, half sine wave, 3 shocks each plane;
DIN IEC 68 T2 - 27
2. Vibration: 10 Hz to 500 Hz, 0,35 mm or 5 g respectively, 1 octave per min, 10 cycles per plane, 3 planes; DIN IEC 68 T2 - 6
3. Change of temperature: -55 °C to 125°C / 30 min. each / 10 cycles
DIN IEC 68 part 2 – 14 Test N
4. Resistance to solder heat (reflow): reflow possible: three times max.;
for temperature conditions, see page 4: "Air reflow temperature conditions"
5. ESD ANSI/ESD S20.20-1999, class 1A for HBM

This filter is RoHS compliant (2002/95/EG, 2005/618/EG)

Packing

- Tape & Reel: IEC 286 – 3, with exception of value for N and minimum bending radius;
tape type II, embossed carrier tape with top cover tape on the upper side;
- | | |
|---|-------------|
| max. pieces of filters per reel: | 3000 |
| reel of empty components at start: | min. 300 mm |
| reel of empty components at start including leader: | min. 500 mm |
| trailer: | min. 300 mm |

Tape (all dimensions in mm)

- W : 12,00
- Po : 4,00
- Do : 1,50
- E : 1,75
- F : 5,50
- G(min) : 0,75
- P2 : 2,00
- P1 : 8,00
- D1(min) : 1,50
- Ao : 5,30
- Bo : 5,30
- Ct : 9,2 ± 0,1

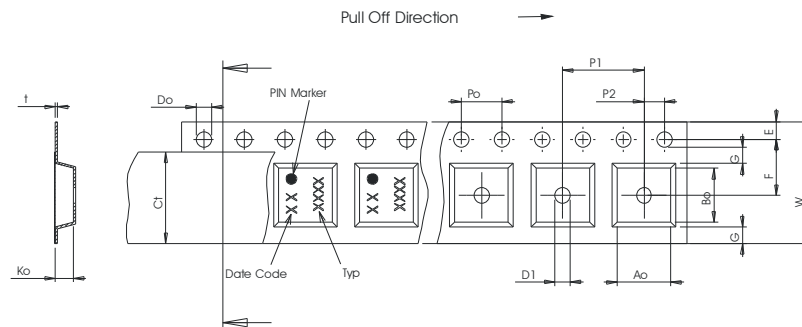

Reel (all dimensions in mm)

- A : 330
- W1 : 12,4 +2/-0
- W2(max) : 18,4
- N(min) : 50
- C : 13,0

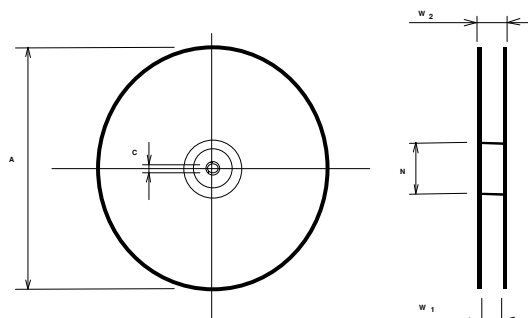

The minimum bending radius is 45 mm.

Vectron International GmbH & Co. KG
Potsdamer Straße 18
D 14 513 TELTOW / Germany
Tel: (+49) 3328 4784-0 / Fax: (+49) 3328 4784-30
E-Mail: tft@vectron.com

Vectron International GmbH & Co. KG reserves the right to make changes to the product(s) and/or information contained herein without notice. No liability is assumed as a result of their use or application. No rights under any patent accompany the sale of any such product(s) or information.

Air reflow temperature conditions

Conditions	Exposure
Average ramp-up rate (30°C to 217°C)	less than 3°C/second
> 100°C	between 300 and 600 seconds
> 150°C	between 240 and 500 seconds
> 217°C	between 30 and 150 seconds
Peak temperature	max. 260°C
Time within 5°C of actual peak temperature	between 10 and 30 seconds
Cool-down rate (Peak to 50°C)	less than 6°C/second
Time from 30°C to Peak temperature	no greater than 300 seconds

Chip-mount air reflow profile

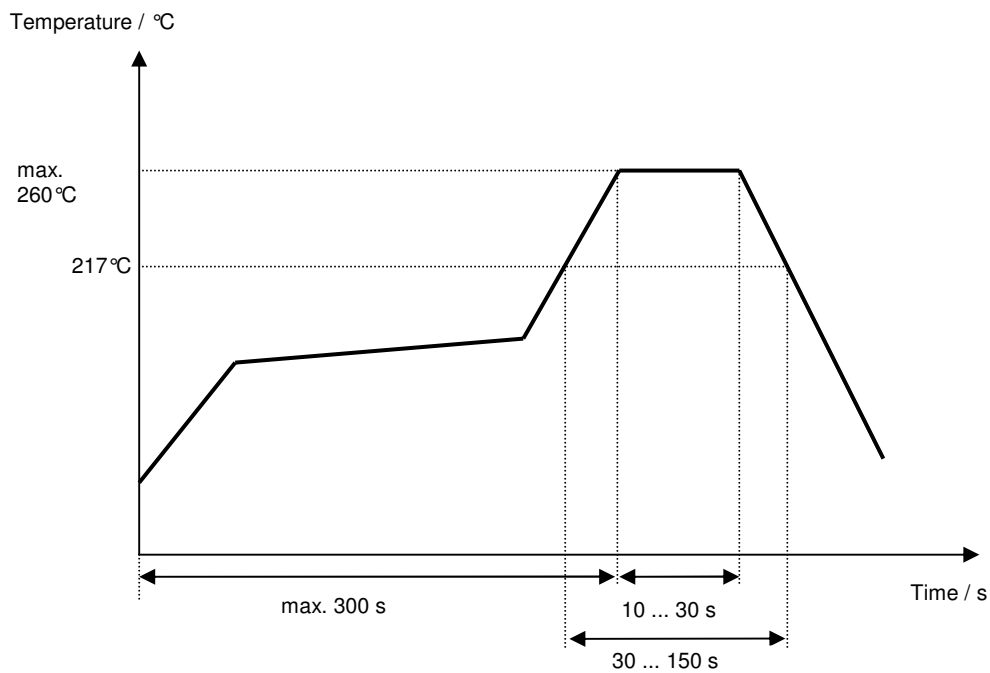

Vectron International GmbH & Co. KG
 Potsdamer Straße 18
 D 14 513 TELTOW / Germany
 Tel: (+49) 3328 4784-0 / Fax: (+49) 3328 4784-30
 E-Mail: tft@vectron.com

Vectron International GmbH & Co. KG reserves the right to make changes to the product(s) and/or information contained herein without notice. No liability is assumed as a result of their use or application. No rights under any patent accompany the sale of any such product(s) or information.

History

Version	Reason of Changes	Name	Date
1.0	- Generation of specification on base of TFS400F	Martens	07.09.2011