

**Vectron International**

**Filter specification**

**TFS 434H**

**1/5**

**Measurement condition**

Ambient temperature:	25	°C
Input power level:	0	dBm
Terminating impedance: *		
Input:	218 Ω    -2,6 pF	
Output:	218 Ω    -2,6 pF	

**Characteristics**

Remark:

The reference level for the relative attenuation  $a_{rel}$  of the TFS 434H is the minimum of the pass band attenuation. This value is defined as the insertion loss  $a_e$ . The nominal frequency  $f_N$  is fixed at 434,46 MHz without any tolerance.

<b>D a t a</b>		<b>typ. value</b>	<b>tolerance / limit</b>
<b>Insertion loss</b> (reference level)	$a_e$	1,9 dB	max. 4,0 dB
<b>Nominal frequency</b>	$f_N$	-	434,46 MHz
<b>Passband</b>	PB1		$f_N \pm 0,22$ MHz
<b>Pass band ripple</b>	p-p	0,2 dB	max. 3,0 dB
<b>Passband 2</b>	PB2		$f_N \pm 0,28$ MHz
<b>Pass band ripple 2</b>	p-p	1 dB	max. 6,0 dB
<b>Relative attenuation</b>	$a_{rel}$		
$f_N - 424,46$ MHz ... $f_N - 19,96$ MHz		44 dB	min. 39,0 dB
$f_N - 19,96$ MHz ... $f_N - 5,96$ MHz		43 dB	min. 35,0 dB
$f_N - 5,96$ MHz ... $f_N - 1,34$ MHz		17 dB	min. 15,0 dB
$f_N + 0,96$ MHz ... $f_N + 8,04$ MHz		26 dB	min. 10,0 dB
$f_N + 8,04$ MHz ... $f_N + 115,54$ MHz		39 dB	min. 35,0 dB
$f_N + 115,54$ MHz ... $f_N + 565,54$ MHz		46 dB	min. 40,0 dB
<b>Input power level</b>			max. 8** dBm
<b>Permissible DC voltage</b>			max. 0 V
<b>Operable temperature range</b>		-	- 45 °C ... + 90 °C
<b>Operating temperature range</b>	OTR	-	+ 25 °C
<b>Storage temperature range</b>		-	- 45 °C ... + 90 °C
<b>Frequency inversion temperature</b>		25 °C	
<b>Temperature coefficient of frequency</b>	$TC_f$ ***	-0,03 ppm/K <sup>2</sup>	

\*) The terminating impedances depend on parasitics and q-values of matching elements and the board used, and are to be understood as reference values only. Should there be additional questions do not hesitate to ask for an application note or contact our design team.

\*\*) 10dBm at cycle time 1/8.

\*\*\*)  $\Delta f(\text{Hz}) = TC_f(\text{ppm/K}^2) \times (T-T_0)^2 \times f_{cat}(\text{MHz})$ .

**Generated:**

---

**Checked / Approved:**

---

**Filter characteristic**

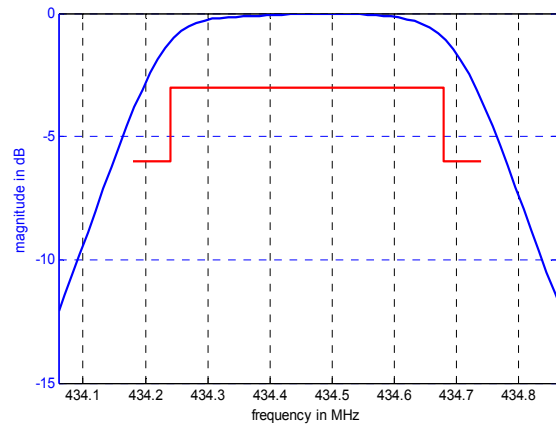
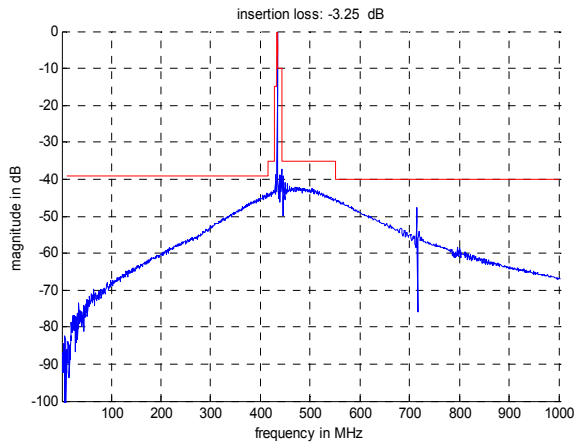

**Construction and pin connection**

(All dimensions in mm)

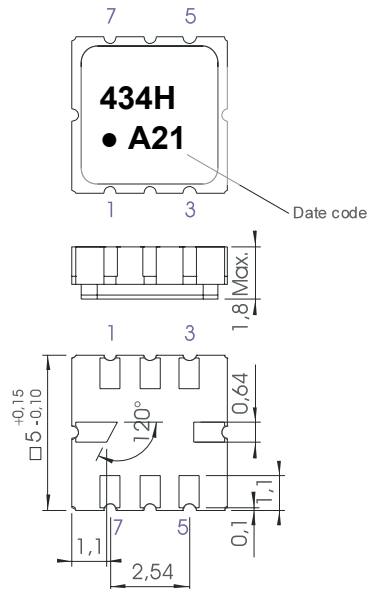

- 1 Ground
- 2 Input
- 3 Ground
- 4 Ground
- 5 Ground
- 6 Output
- 7 Ground
- 8 Ground

Date code: Year + week  
 A 2010  
 B 2011  
 C 2012  
 ...

**50 Ω Test circuit**

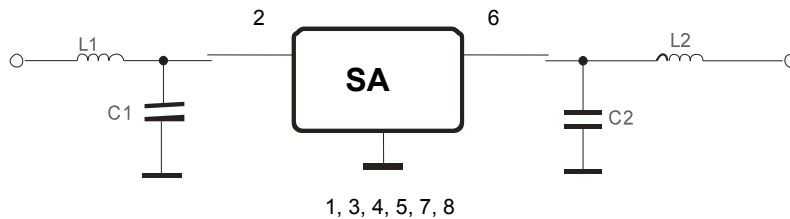

**Vectron International GmbH & Co. KG**  
 Potsdamer Straße 18  
 D 14 513 TELTOW / Germany  
 Tel: (+49) 3328 4784-0 / Fax: (+49) 3328 4784-30  
 E-Mail: [tft@vectron.com](mailto:tft@vectron.com)

Vectron International GmbH & Co. KG reserves the right to make changes to the product(s) and/or information contained herein without notice. No liability is assumed as a result of their use or application. No rights under any patent accompany the sale of any such product(s) or information.

**Stability characteristics, reliability**

After the following tests the filter shall meet the whole specification:

1. Shock: 500g, 1 ms, half sine wave, 3 shocks each plane;  
DIN IEC 68 T2 - 27
2. Vibration: 10 Hz to 500 Hz, 0,35 mm or 5 g respectively, 1 octave per min, 10 cycles per plan, 3 plans;  
DIN IEC 68 T2 - 6
3. Change of temperature: -55 °C to 125°C / 30 min. each / 10 cycles  
DIN IEC 68 part 2 – 14 Test N
4. Resistance to solder heat (reflow): reflow possible: three times max.;  
for temperature conditions refer to the attached "Air reflow temperature conditions" on page 4;
5. ESD MIL-STD-883E using coupling network of ISO 10605 and EN 6100-4-2  
HBM:250V; CDM:V;

This filter is RoHS compliant (2002/95/EG, 2005/618/EG)

**Packing**

Tape & Reel: IEC 286 – 3, with exception of value for N and minimum bending radius;  
tape type II, embossed carrier tape with top cover tape on the upper side;

max. pieces of filters per reel:	3000
reel of empty components at start:	min. 300 mm
reel of empty components at start including leader:	min. 500 mm
trailer:	min. 300 mm

**Tape (all dimensions in mm)**

- W : 12,00
- Po : 4,00
- Do : 1,50
- E : 1,75
- F : 5,50
- G(min) : 0,75
- P2 : 2,00
- P1 : 8,00
- D1(min) : 1,50
- Ao : 5,30
- Bo : 5,30
- Ct : 9,5

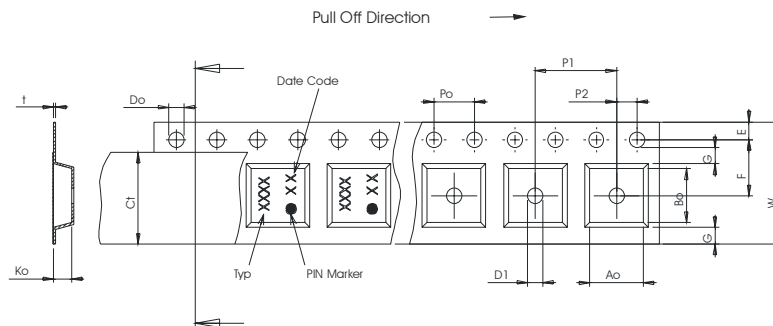

**Reel (all dimensions in mm)**

- A : 330
- W1 : 12,4
- W2(max) : 18,4
- N(min) : 50
- C : 13,0

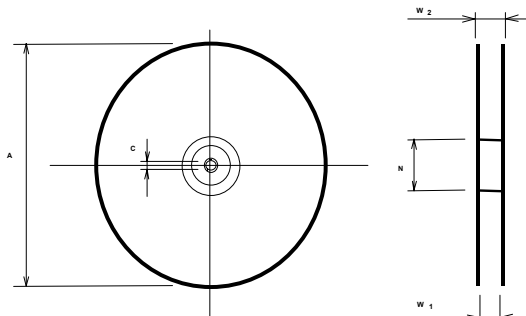

The minimum bending radius is 45 mm.

**Vectron International GmbH & Co. KG**  
**Potsdamer Straße 18**  
**D 14 513 TELTOW / Germany**  
**Tel: (+49) 3328 4784-0 / Fax: (+49) 3328 4784-30**  
**E-Mail: [tft@vectron.com](mailto:tft@vectron.com)**

Vectron International GmbH & Co. KG reserves the right to make changes to the product(s) and/or information contained herein without notice. No liability is assumed as a result of their use or application. No rights under any patent accompany the sale of any such product(s) or information.

**Air reflow temperature conditions**

<b>Conditions</b>	<b>Exposure</b>
Average ramp-up rate (30°C to 217°C)	less than 3°C/second
> 100°C	between 300 and 600 seconds
> 150°C	between 240 and 500 seconds
> 217°C	between 30 and 150 seconds
Peak temperature	max. 260°C
Time within 5°C of actual peak temperature	between 10 and 30 seconds
Cool-down rate (Peak to 50°C)	less than 6°C/second
Time from 30°C to Peak temperature	no greater than 300 seconds

**Chip-mount air reflow profile**

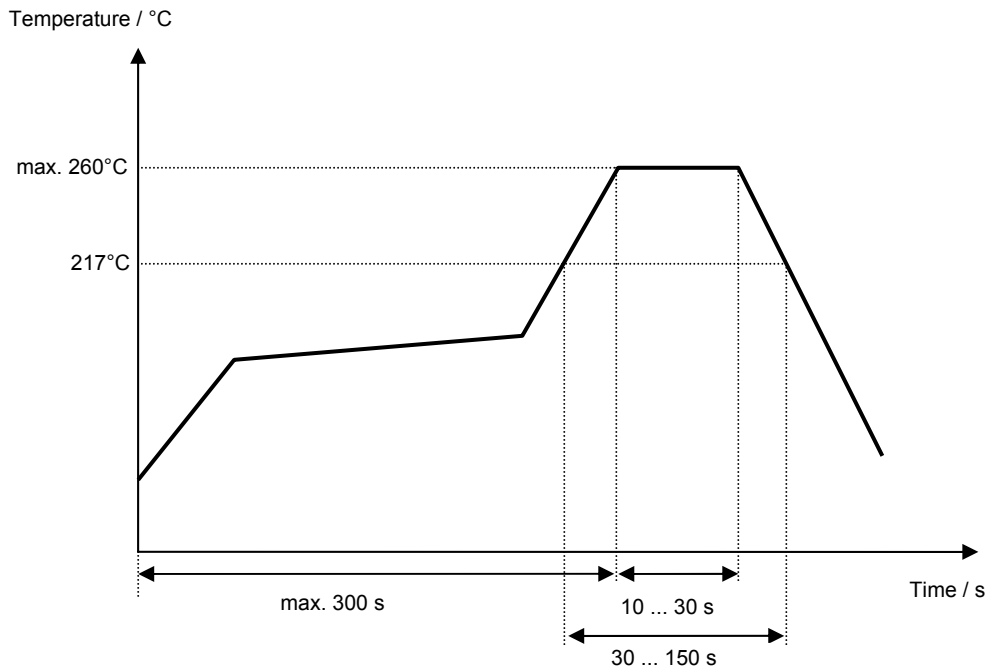

**Vectron International GmbH & Co. KG**  
 Potsdamer Straße 18  
 D 14 513 TELTOW / Germany  
 Tel: (+49) 3328 4784-0 / Fax: (+49) 3328 4784-30  
 E-Mail: [tft@vectron.com](mailto:tft@vectron.com)

Vectron International GmbH & Co. KG reserves the right to make changes to the product(s) and/or information contained herein without notice. No liability is assumed as a result of their use or application. No rights under any patent accompany the sale of any such product(s) or information.

**History**

<b>Version</b>	<b>Reason of Changes</b>	<b>Name</b>	<b>Date</b>
1.0	- Generation of filter specification	S. Channaa	10.06.2009
1.1	- Change Input power level	S. Channaa	26.05.2010