

Measurement condition

Ambient temperature:	85	°C
Input power level:	0	dBm
Terminating impedance:		
Input:	50	Ω
Output:	50	Ω

Characteristics

Remark:

The minimum of the pass band attenuation a_{\min} is defined as the insertion loss a_e . The centre frequency f_C is the frequency of the minimum of S11. The tolerance for the centre frequency does not include a frequency shift due to the temperature coefficient of frequency TC_f .

D a t a		typ. value	tolerance / limit
Insertion loss (reference level)	$a_e = a_{\min}$	-	max. 2,5 dB
Centre frequency (minimum of S11)	f_C	433.4 MHz	± 12.5 kHz
Quality factor	Unloaded Q	8000	-
Parallel capacitance	C_0	2.7 pF *	-
Motional resistance	R_1	24 Ω *	-
Motional inductance	L_1	90 μH *	-
Motional capacitance	C_1	1.5 fF *	-
Input power level		-	max. 0 dBm
Operating temperature		-	85 °C
Operable temperature range	OTR1	-	- 40°C ... + 125°C
	OTR2	-	- 40°C ... + 180°C
	OTR3	-	- 40°C ... + 220°C
Storage temperature range		-	- 40°C ... + 120°C
Temperature coefficient of frequency	TC_f **	+ 16.2 ppm/K	
Temperature error due to aging ***			
within OTR1		0.29 K	max. - 2 K ... 2 K
within OTR2		2.33 K	max. - 2 K ... 5 K
within OTR3		4.33 K	max. - 2 K ... 8 K

*) The equivalent circuit model is for reference only.

**) $\Delta f(\text{Hz}) = TC_f(\text{ppm/K}) \times (T_0 - T) \times f_{\text{CAT}}(\text{MHz})$.

***) 1000 hours cumulative at maximum temperature

Generated:**Checked / Approved:**

Vectron International GmbH
Potsdamer Straße 18
D 14 513 TELTOW / Germany
Tel: (+49) 3328 4784-0 / Fax: (+49) 3328 4784-30
E-Mail: tft@vectron.com

Vectron International GmbH reserves the right to make changes to the product(s) and/or information contained herein without notice. No liability is assumed as a result of their use or application. No rights under any patent accompany the sale of any such product(s) or information.

Typical ageing error of sensor signal for operation in extended temperature range

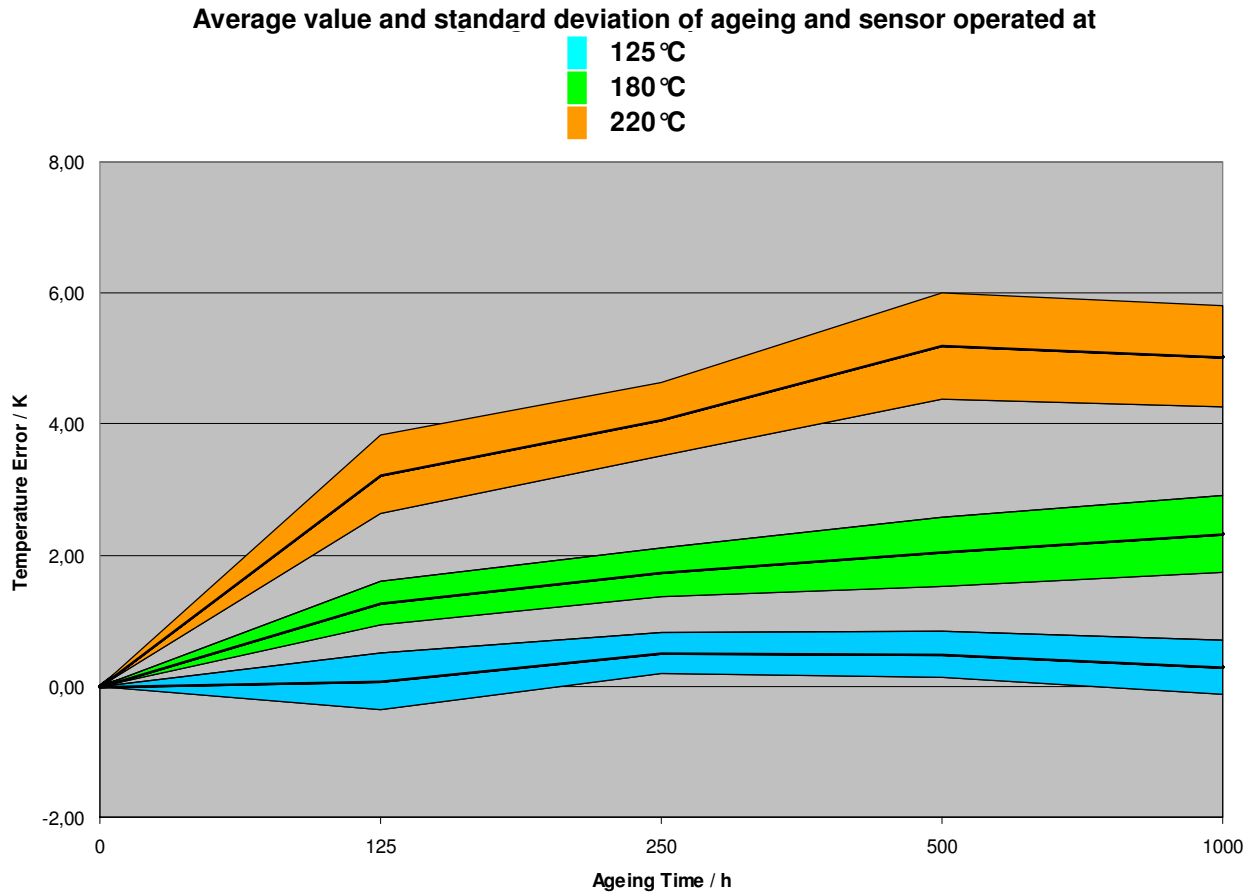

Temperatur sensor characteristic

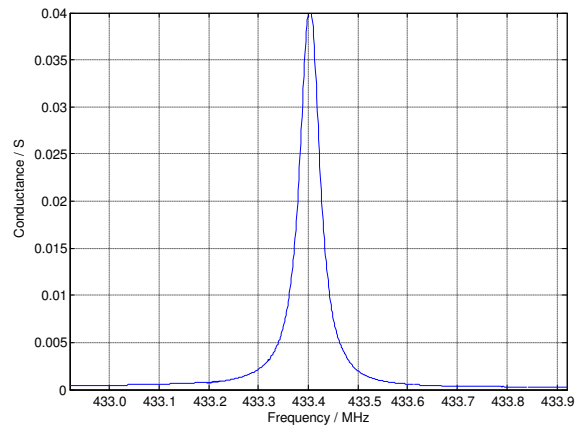
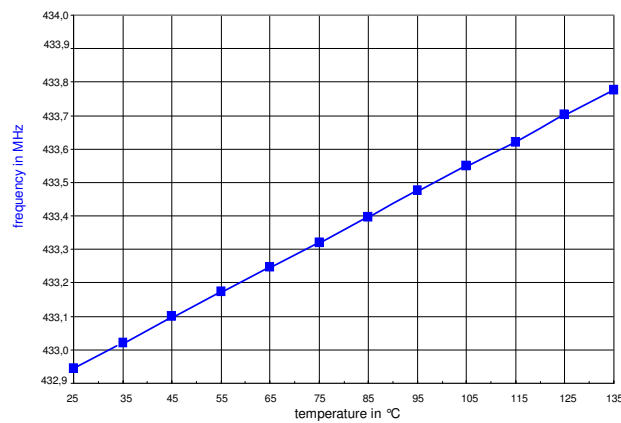

Construction and pin connection

(All dimensions in mm)

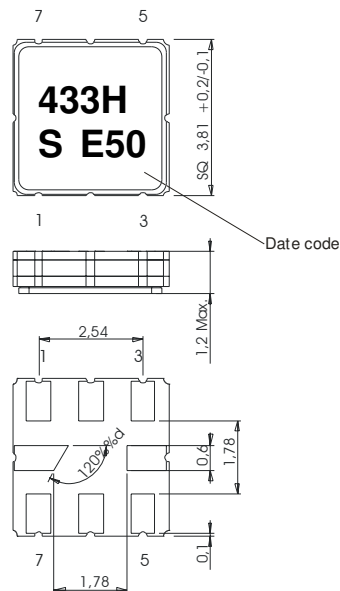

- 1 Ground
- 2 Input
- 3 Ground
- 4 Ground
- 5 Ground
- 6 Ground
- 7 Ground
- 8 Ground

Date code: Year + week
 E 2014
 F 2015
 G 2016
 ...

50 Ohm Test circuit

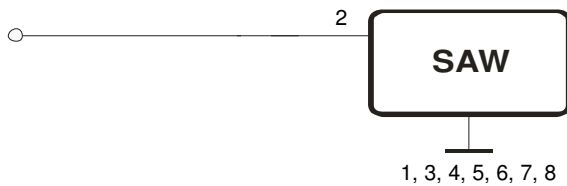

Equivalent circuit

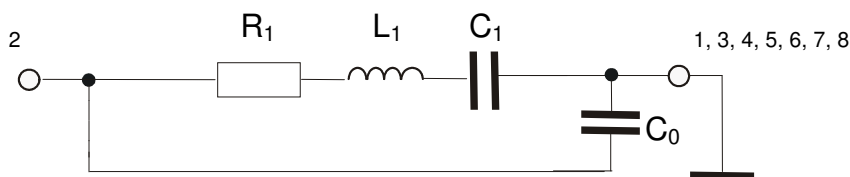

Vectron International GmbH
 Potsdamer Straße 18
 D 14 513 TELTOW / Germany
 Tel: (+49) 3328 4784-0 / Fax: (+49) 3328 4784-30
 E-Mail: tft@vectron.com

Vectron International GmbH reserves the right to make changes to the product(s) and/or information contained herein without notice. No liability is assumed as a result of their use or application. No rights under any patent accompany the sale of any such product(s) or information.

Stability characteristics, reliability

After the following tests the filter shall meet the whole specification:

1. Shock: 500g, 1 ms, half sine wave, 3 shocks each plane;
DIN IEC 68 T2 - 27
2. Vibration: 10 Hz to 500 Hz, 0.35 mm or 5 g respectively, 1 octave per min, 10 cycles per plan, 3 plans;
DIN IEC 68 T2 - 6
3. Change of temperature: -55 °C to 125°C / 15 min. each / 100 cycles
DIN IEC 68 part 2 – 14 Test N
4. Resistance to solder heat (reflow): reflow possible: three times max. ;
for temperature conditions refer to the attached "Air reflow temperature conditions" on page 5;

This filter is RoHS compliant (2011/65/EU)

Packing

Tape & Reel: IEC 286 – 3, with exception of value for N and minimum bending radius;
tape type II, embossed carrier tape with top cover tape on the upper side;

max. pieces of filters per reel:	3000
reel of empty components at start:	min. 300 mm
reel of empty components at start including leader:	min. 500 mm
trailer:	min. 300 mm

Tape (all dimensions in mm)

W	:12.00 ± 0.3
Po	:4.00 ± 0.1
Do	:1.50 +0.1/-0
E	:1.75 ± 0.1
F	:5.50 ± 0.05
G(min)	:0.75
P2	:2.00 ± 0.05
P1	:8.00 ± 0.1
D1(min)	:1.50
Ao	:4.30 ± 0.1
Bo	:4.30 ± 0.1
Ct	: 9.5 ± 0.1

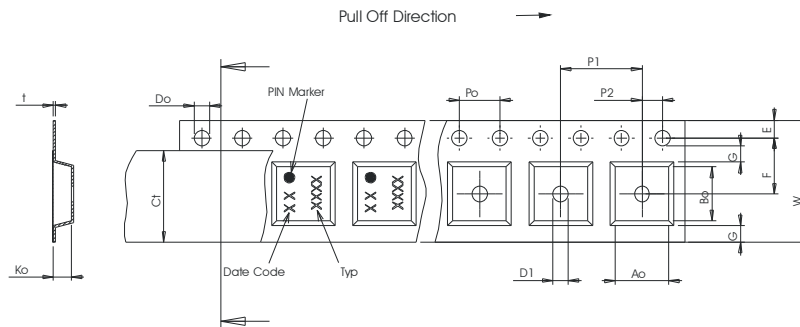

Reel (all dimensions in mm)

A	: 330 or 180
W1	:12.4 +2/-0
W2(max)	:18.4
N(min)	: 50
C	:13.0 +0.5/-0,2

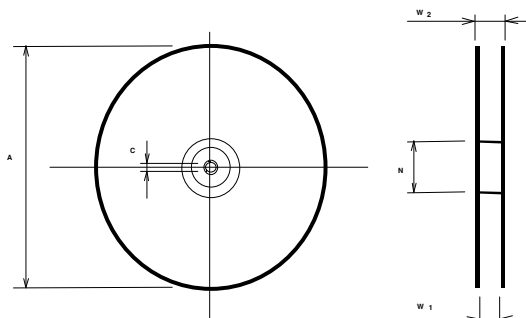

The minimum bending radius is 45 mm.

Vectron International GmbH
Potsdamer Straße 18
D 14 513 TELTOW / Germany
Tel: (+49) 3328 4784-0 / Fax: (+49) 3328 4784-30
E-Mail: tft@vectron.com

Vectron International GmbH reserves the right to make changes to the product(s) and/or information contained herein without notice. No liability is assumed as a result of their use or application. No rights under any patent accompany the sale of any such product(s) or information.

Air reflow temperature conditions

Conditions	Exposure
Average ramp-up rate (30°C to 217°C)	less than 3°C/second
> 100°C	between 300 and 600 seconds
> 150°C	between 240 and 500 seconds
> 217°C	between 30 and 150 seconds
Peak temperature	max. 260°C
Time within 5°C of actual peak temperature	between 10 and 30 seconds
Cool-down rate (Peak to 50°C)	less than 6°C/second
Time from 30°C to Peak temperature	no greater than 300 seconds

Chip-mount air reflow profile

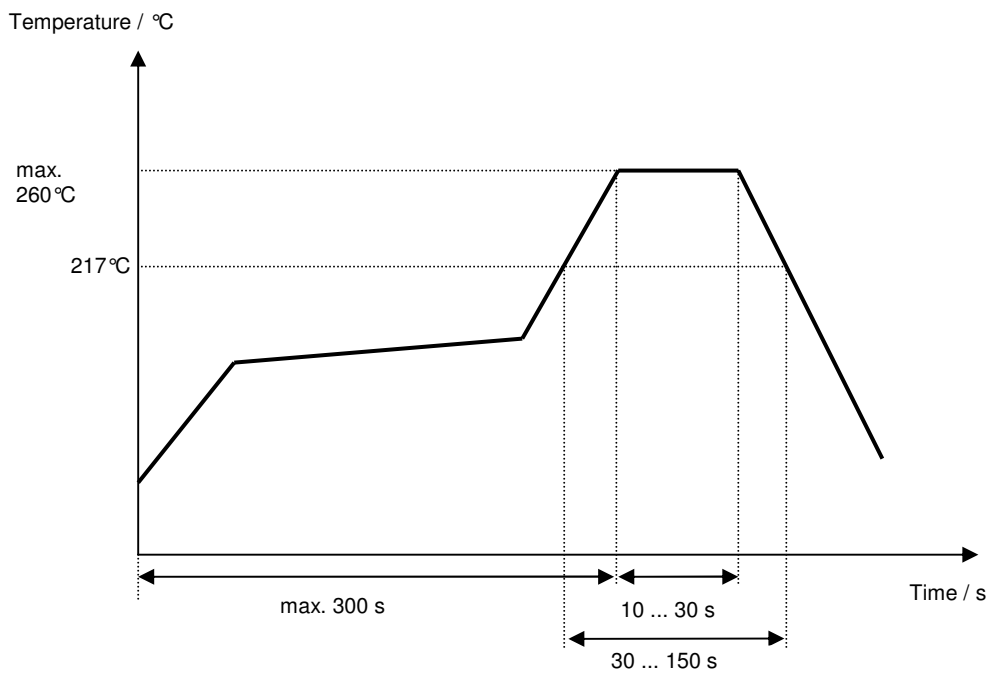

Vectron International GmbH
 Potsdamer Straße 18
 D 14 513 TELTOW / Germany
 Tel: (+49) 3328 4784-0 / Fax: (+49) 3328 4784-30
 E-Mail: tft@vectron.com

Vectron International GmbH reserves the right to make changes to the product(s) and/or information contained herein without notice. No liability is assumed as a result of their use or application. No rights under any patent accompany the sale of any such product(s) or information.

History

Version	Reason of Changes	Name	Date
1.0	- Generation of development specification	Strehl	10.12.2007
1.1	- Introduce temperature error caused by aging in data table - Changed from development specification to temperature sensor specification - Add typical values for motional parameters	Raura	14.12.2009
2.0	- Changed f_c tolerance/limit in data table - Updated stability characteristics, reliability section - Changed pin marker direction in packing tape & reel section - Changed punctuation marks from comma to period	Raura	11.12.2014