

Vectron International

Filter specification

TFS 1960

1/5

Measurement condition

Ambient temperature:	23	°C
Input power level:	0	dBm
Terminating impedance:		
Input:	50	Ω
Output:	50	Ω

Characteristics

Remark:

The maximum attenuation in the pass band is defined as the insertion loss a_e . The nominal frequency f_N is fixed at 1960 MHz without any tolerance or limit. The values of absolute attenuation a_{abs} are guaranteed for the whole operating temperature range. The frequency shift of the filter in the operating temperature range is included in the production tolerance scheme.

D a t a		typ. value		tolerance / limit	
Insertion loss		a_e	2,9 dB	max.	4,3 dB
Insertion loss in OTR2			2,7 dB	max.	4,1 dB
Nominal frequency		f_N	-	1960	MHz
Passband		PB		$f_N \pm 30$	MHz
Pass band ripple			0,6 dB	max.	2 dB
Pass band variation			1,5 dB	max.	3 dB
Absolute attenuation		a_{abs}			
10	MHz ... 1850	MHz	33 dB	min.	24 dB
1850	MHz ... 1910	MHz	17 dB	min.	10,5 dB
1850	MHz ... 1910	MHz in OTR2	18 dB	min.	11,5 dB
2010	MHz ... 2040	MHz	6 dB	min.	4,5 dB
2010	MHz ... 2040	MHz in OTR2	7 dB	min.	5,5 dB
2040	MHz ... 2070	MHz	45 dB	min.	30 dB
2070	MHz ... 2500	MHz	43 dB	min.	23 dB
2500	MHz ... 2700	MHz	43 dB	min.	32 dB
2700	MHz ... 4000	MHz	31 dB	min.	28 dB
4000	MHz ... 6000	MHz	7 dB	min.	5 dB
Input power level			-	max.	10 dBm
Operating temperature range		OTR	-	- 30 °C ... + 85 °C	
Operating temperature range2		OTR2	-	- 10 °C ... + 70 °C	
Storage temperature range			-	- 40 °C ... + 85 °C	
Temperature coefficient of frequency		TC_f *	-46 ppm/K		

*) $\Delta f(\text{Hz}) = TC_f(\text{ppm/K}) \times (T - T_0) \times f_{T0}(\text{MHz})$

Generated:

Checked / Approved:

Vectron International GmbH
Potsdamer Straße 18
D 14 513 TELTOW / Germany
Tel: (+49) 3328 4784-0 / Fax: (+49) 3328 4784-30
E-Mail: tft@vectron.com

Vectron International GmbH reserves the right to make changes to the product(s) and/or information contained herein without notice. No liability is assumed as a result of their use or application. No rights under any patent accompany the sale of any such product(s) or information.

Filter characteristic

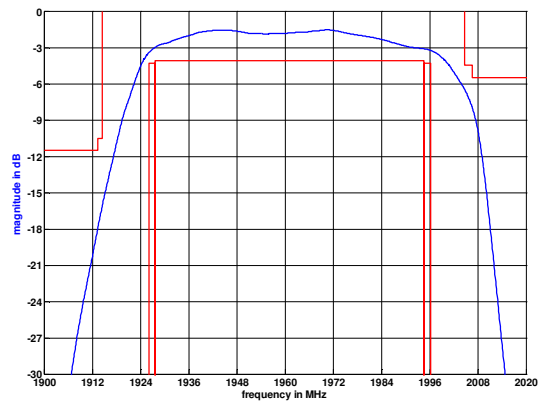
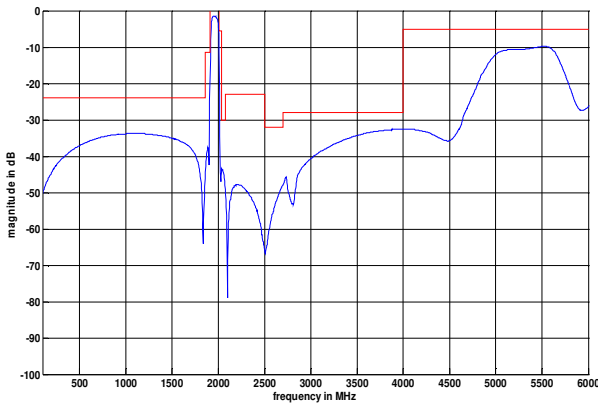

Construction and pin connection

(All dimensions in mm)

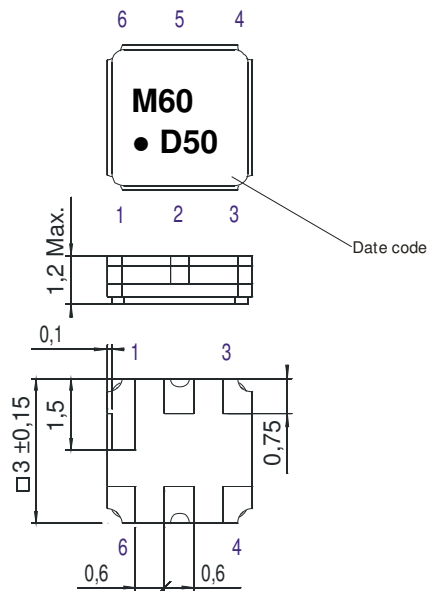

- 1 Ground
- 2 Input
- 3 Ground
- 4 Ground
- 5 Output
- 6 Ground

Date code: Year + week
 C 2012
 D 2013
 E 2014

50 Ohm Test circuit

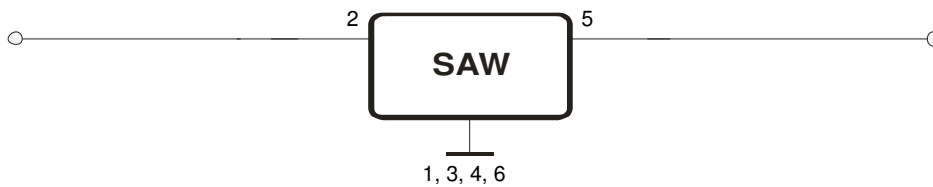

Vectron International GmbH
 Potsdamer Straße 18
 D 14 513 TELTOW / Germany
 Tel: (+49) 3328 4784-0 / Fax: (+49) 3328 4784-30
 E-Mail: tft@vectron.com

Vectron International GmbH reserves the right to make changes to the product(s) and/or information contained herein without notice. No liability is assumed as a result of their use or application. No rights under any patent accompany the sale of any such product(s) or information.

Stability characteristics, reliability

After the following tests the filter shall meet the whole specification:

1. Shock: 500g, 1 ms, half sine wave, 3 shocks each plane;
DIN IEC 68 T2 - 27
2. Vibration: 10 Hz to 500 Hz, 0,35 mm or 5 g respectively, 1 octave per min, 10 cycles per plan, 3 plans;
DIN IEC 68 T2 - 6
3. Change of temperature: -55 °C to 125°C / 15 min. each / 100 cycles
DIN IEC 68 part 2 – 14 Test N
4. Resistance to solder heat (reflow): reflow possible: three times max.;
for temperature conditions refer to the attached "Air reflow temperature conditions" on page 4;

This filter is RoHS compliant (20011/65/EU)

Packing

Tape & Reel: IEC 286 – 3, with exception of value for N and minimum bending radius;
tape type II, embossed carrier tape with top cover tape on the upper side;

max. pieces of filters per reel:	3000
reel of empty components at start:	min. 300 mm
reel of empty components at start including leader:	min. 500 mm
trailer:	min. 300 mm

Tape (all dimensions in mm)

- W : 8,00 ± 0,3
- Po : 4,00 ± 0,1
- Do : 1,50 +0,1/-0
- E : 1,75 ± 0,1
- F : 3,50 ± 0,05
- G(min) : 0,75
- P2 : 2,00 ± 0,05
- P1 : 4,00 ± 0,1
- D1(min) : 1,50
- Ao : 3,25 ± 0,1
- Bo : 3,25 ± 0,1
- Ct : 5,3 ± 0,1

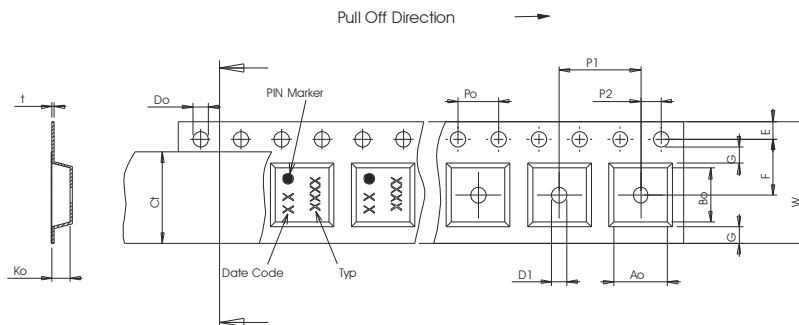

Reel (all dimensions in mm)

- A : 180
- W1 : 8,4 +1,5/-0
- W2(max) : 14,4
- N(min) : 60
- C : 13,0 ± 0,2

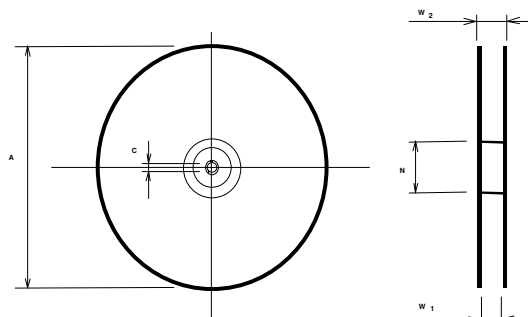

The minimum bending radius is 45 mm.

Vectron International GmbH
Potsdamer Straße 18
D 14 513 TELTOW / Germany
Tel: (+49) 3328 4784-0 / Fax: (+49) 3328 4784-30
E-Mail: tft@vectron.com

Vectron International GmbH reserves the right to make changes to the product(s) and/or information contained herein without notice. No liability is assumed as a result of their use or application. No rights under any patent accompany the sale of any such product(s) or information.

Air reflow temperature conditions

Conditions	Exposure
Average ramp-up rate (30°C to 217°C)	less than 3°C/second
> 100°C	between 300 and 600 seconds
> 150°C	between 240 and 500 seconds
> 217°C	between 30 and 150 seconds
Peak temperature	max. 260°C
Time within 5°C of actual peak temperature	between 10 and 30 seconds
Cool-down rate (Peak to 50°C)	less than 6°C/second
Time from 30°C to Peak temperature	no greater than 300 seconds

Chip-mount air reflow profile

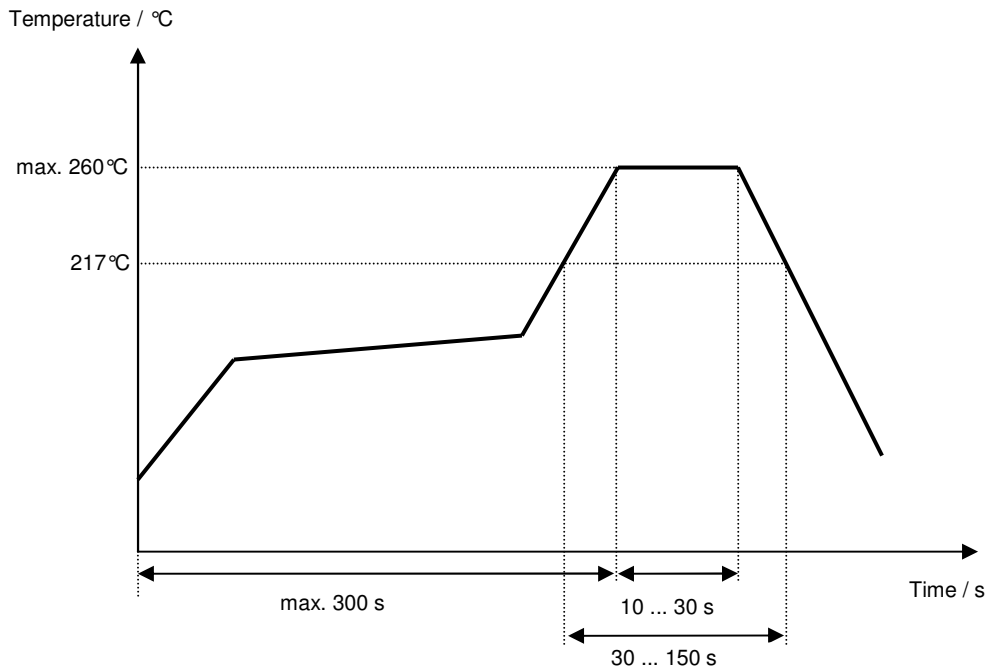

Vectron International GmbH
 Potsdamer Straße 18
 D 14 513 TELTOW / Germany
 Tel: (+49) 3328 4784-0 / Fax: (+49) 3328 4784-30
 E-Mail: tft@vectron.com

Vectron International GmbH reserves the right to make changes to the product(s) and/or information contained herein without notice. No liability is assumed as a result of their use or application. No rights under any patent accompany the sale of any such product(s) or information.

History

Version	Reason of Changes	Name	Date
1.0	Generation of development specification	Roizengaft	19.12.2003
1.1	add of formula for temperature coefficient of frequency, add of value of temperature coefficient, change of operating temperature range, change of absolute attenuation	Roizengaft	22.12.2003
1.2	add of typical values	Dr. Sabah	08.01.2004
1.3	generation of filter specification added OTR 2 changed limit line scheme changed temperature coefficient added filter characteristic	Martens	11.12.2006
1.4	changed limit line scheme	Noack	25.10.2007
1.5	added filter characteristic	Strehl	12.08.2008
2.0	change data table and filter characteristic	Noack	12.04.2010
2.1	changing power level changing tape and reel direction	S.Springfeldt	01.12.2011
2.2	changing power level	S. Springfeldt	11.12.2013