

**Vectron International**

**Filter specification**

**TFS 1950B**

**1/5**

**Measurement condition**

Ambient temperature:	23	°C
Input power level:	0	dBm
Terminating impedance:		
Input:	50	Ω
Output:	50	Ω

**Characteristics**

Remark:

The maximum attenuation in the pass band is defined as the insertion loss  $a_e$ . The nominal frequency  $f_N$  is fixed at 1950 MHz without any tolerance or limit. The values of absolute attenuation  $a_{abs}$  are guaranteed for the whole operating temperature range. The frequency shift of the filter in the operating temperature range is included in the production tolerance scheme.

<b>D a t a</b>	<b>typ. value</b>		<b>tolerance / limit</b>		
<b>Insertion loss</b>	$a_e$	2,6	dB	max. 3,0	dB
<b>Nominal frequency</b>	$f_N$			1950	MHz
<b>Passband</b>	PB			$f_N \pm 30$	MHz
<b>Pass band variation</b>		1,3	dB	max. 1,5	dB
<b>Absolute attenuation</b>	$a_{abs}$				
0,3 MHz ... 1805 MHz		31	dB	min. 20	dB
1805 MHz ... 1880 MHz		38	dB	min. 30	dB
1880 MHz ... 1900 MHz		9	dB	min. 5	dB
2010 MHz ... 2110 MHz		28	dB	min. 5	dB
2110 MHz ... 2170 MHz		43	dB	min. 40	dB
2170 MHz ... 3000 MHz		43	dB	min. 20	dB
<b>Input power level</b>		-		max. 15	dBm
<b>Operating temperature range</b>	OTR	-		- 40 °C ... + 85 °C	
<b>Storage temperature range</b>		-		- 40 °C ... + 85 °C	
<b>Temperature coefficient of frequency</b>	$TC_f$ *	-46	ppm/K		

\*)  $\Delta f(\text{Hz}) = TC_f(\text{ppm/K}) \times (T - T_0) \times f_{T0}(\text{MHz})$

**Generated:**

---

**Checked / Approved:**

---

**Vectron International GmbH & Co. KG**  
**Potsdamer Straße 18**  
**D 14 513 TELTOW / Germany**  
**Tel: (+49) 3328 4784-0 / Fax: (+49) 3328 4784-30**  
**E-Mail: [ift@vectron.com](mailto:ift@vectron.com)**

Vectron International GmbH & Co. KG reserves the right to make changes to the product(s) and/or information contained herein without notice. No liability is assumed as a result of their use or application. No rights under any patent accompany the sale of any such product(s) or information.

**Filter characteristic**

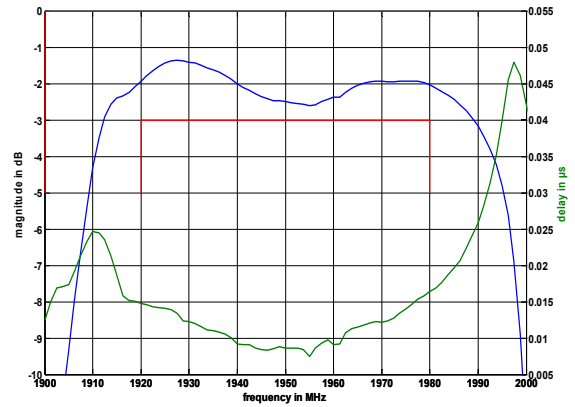
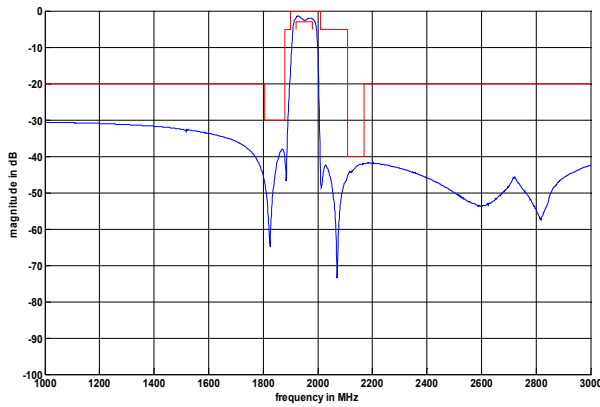

**Construction and pin connection**

(All dimensions in mm)

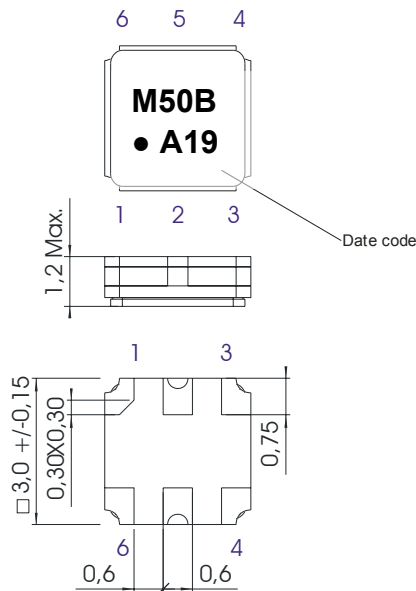

- 1 Ground
- 2 Input
- 3 Ground
- 4 Ground
- 5 Output
- 6 Ground

Date code: Year + week  
 A 2010  
 B 2011  
 C 2012  
 ...

**50 Ω Test circuit**

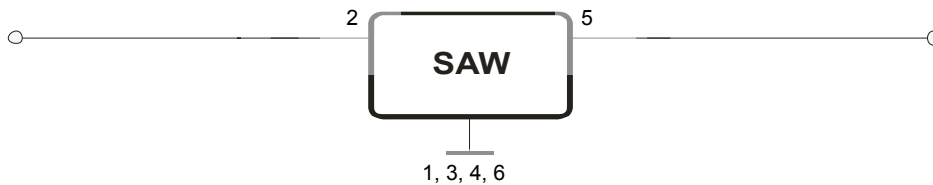

**Vectron International GmbH & Co. KG**  
 Potsdamer Straße 18  
 D 14 513 TELTOW / Germany  
 Tel: (+49) 3328 4784-0 / Fax: (+49) 3328 4784-30  
 E-Mail: [ift@vectron.com](mailto:ift@vectron.com)

Vectron International GmbH & Co. KG reserves the right to make changes to the product(s) and/or information contained herein without notice. No liability is assumed as a result of their use or application. No rights under any patent accompany the sale of any such product(s) or information.

**Stability characteristics, reliability**

After the following tests the filter shall meet the whole specification:

1. Shock: 500g, 1 ms, half sine wave, 3 shocks each plane;  
DIN IEC 68 T2 - 27
2. Vibration: 10 Hz to 500 Hz, 0,35 mm or 5 g respectively, 1 octave per min, 10 cycles per plane, 3 planes;  
DIN IEC 68 T2 - 6
3. Change of temperature: -55 °C to 125°C / 30 min. each / 10 cycles  
DIN IEC 68 part 2 – 14 Test N
4. Resistance to solder heat (reflow): reflow possible: three times max.;  
for temperature conditions refer to the attached "Air reflow temperature conditions" on page 4;

This filter is RoHS compliant (2002/95/EG, 2005/618/EG)

**Packing**

Tape & Reel: IEC 286 – 3, with exception of value for N and minimum bending radius;  
tape type II, embossed carrier tape with top cover tape on the upper side;

max. pieces of filters per reel:	9000
reel of empty components at start:	min. 300 mm
reel of empty components at start including leader:	min. 500 mm
trailer:	min. 300 mm

**Tape (all dimensions in mm)**

- W : 8,00 ± 0,3
- Po : 4,00 ± 0,1
- Do : 1,50 +0,1/-0
- E : 1,75 ± 0,1
- F : 3,50 ± 0,05
- G(min) : 0,75
- P2 : 2,00 ± 0,05
- P1 : 4,00 ± 0,1
- D1(min) : 1,50
- Ao : 3,25 ± 0,1
- Bo : 3,25 ± 0,1
- Ct : 5,5 ± 0,1

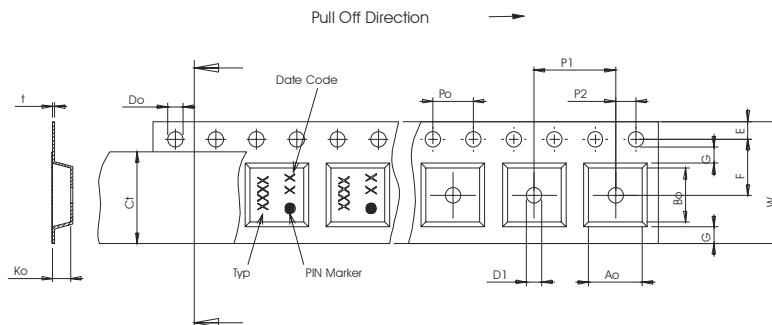

**Reel (all dimensions in mm)**

- A : 330
- W1 : 8,4 +1,5/-0
- W2(max) : 14,4
- N(min) : 50
- C : 13,0 +0,5/-0,2

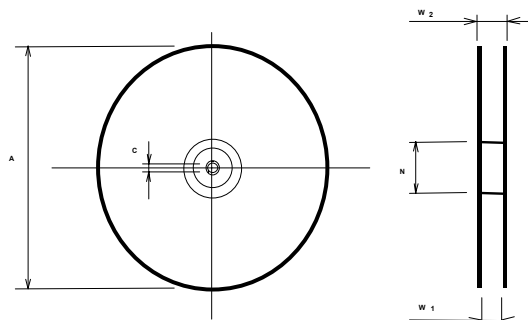

The minimum bending radius is 45 mm.

**Vectron International GmbH & Co. KG**  
**Potsdamer Straße 18**  
**D 14 513 TELTOW / Germany**  
**Tel: (+49) 3328 4784-0 / Fax: (+49) 3328 4784-30**  
**E-Mail: [ift@vectron.com](mailto:ift@vectron.com)**

Vectron International GmbH & Co. KG reserves the right to make changes to the product(s) and/or information contained herein without notice. No liability is assumed as a result of their use or application. No rights under any patent accompany the sale of any such product(s) or information.

## Air reflow temperature conditions

Conditions	Exposure
Average ramp-up rate (30°C to 217°C)	less than 3°C/second
> 100°C	between 300 and 600 seconds
> 150°C	between 240 and 500 seconds
> 217°C	between 30 and 150 seconds
Peak temperature	max. 260°C
Time within 5°C of actual peak temperature	between 10 and 30 seconds
Cool-down rate (Peak to 50°C)	less than 6°C/second
Time from 30°C to Peak temperature	no greater than 300 seconds

Chip-mount air reflow profile

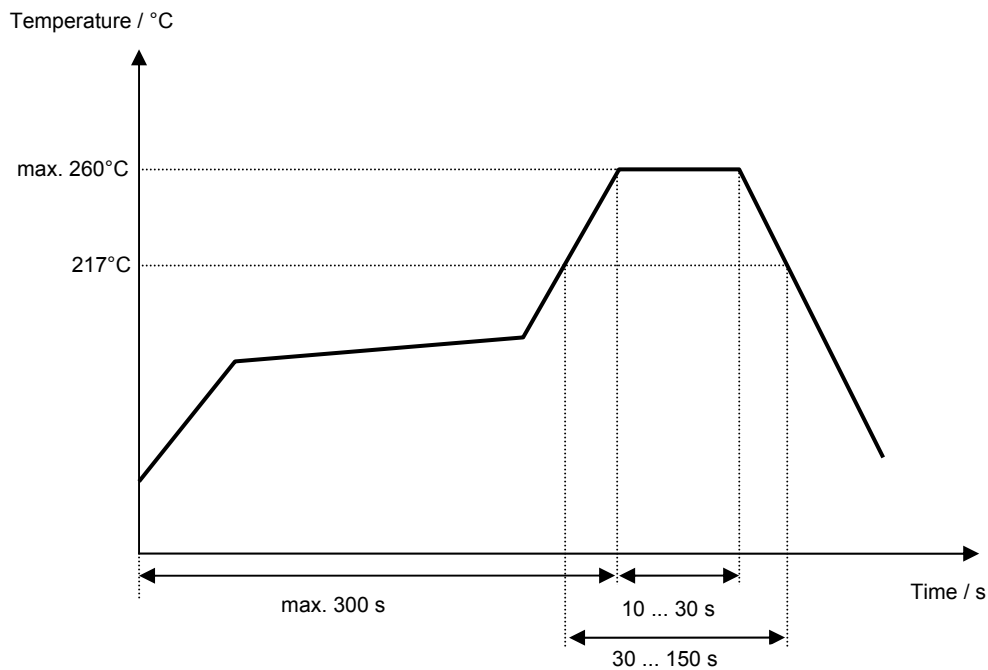

**History**

<b>Version</b>	<b>Reason of Changes</b>	<b>Name</b>	<b>Date</b>
1.0	Generation of development specification	Noack	29.01.2010
2.0	Change data table according to new customer requirement	Noack	09.03.2010
2.1	Generation of filter specification Add typical values and filter characteristic	Noack	03.05.2010