

VI TELEFILTER

Filter specification

TFS 897D

1/5

Measurement condition

Ambient temperature:	23	°C
Input power level:	0	dBm
Terminating impedance: *		
Input:	56 Ω -1,4 pF	
Output:	55 Ω -1,3 pF	

Characteristics

Remark:

The maximum attenuation in the pass band is defined as the insertion loss a_e . The nominal frequency f_N is fixed at 897,5 MHz without any tolerance or limit. The values of absolute attenuation a_{abs} are guaranteed for the whole operating temperature range. The frequency shift of the filter in the operating temperature range is included in the production tolerance scheme.

D a t a		typ. value		tolerance / limit	
Insertion loss	a_e	2,6	dB	max.	2,9 dB
Insertion loss in OTR2		2,9	dB	max.	3,5 dB
Nominal frequency	f_N	-			897,5 MHz
Passband	PB	-		$f_N \pm$	17,5 MHz
Pass band variation		1,0	dB	max.	1,3 dB
Pass band variation in OTR2		1,5	dB	max.	2,0 dB
Pass band variation in any 5 MHz window	**	0,4	dB	max.	1,0 dB
Pass band variation in any 5 MHz window in OTR2		0,4	dB	max.	1,3 dB
Pass band variation in any 5 MHz window at 23°C		0,3	dB	max.	0,8 dB
Absolute attenuation	a_{abs}				
1 MHz ... 620 MHz		56	dB	min.	40 dB
620 MHz ... 840 MHz		50	dB	min.	35 dB
925 MHz ... 926 MHz		16	dB	min.	10 dB
925 MHz ... 926 MHz	in OTR2	8	dB	min.	6 dB
926 MHz ... 927 MHz		21	dB	min.	14 dB
926 MHz ... 927 MHz	in OTR2	15	dB	min.	11 dB
927 MHz ... 928 MHz		21	dB	min.	18 dB
927 MHz ... 928 MHz	in OTR2	21	dB	min.	16 dB
928 MHz ... 929 MHz		24	dB	min.	22 dB
928 MHz ... 929 MHz	in OTR2	24	dB	min.	20 dB
929 MHz ... 940 MHz		32	dB	min.	26 dB
940 MHz ... 960 MHz		42	dB	min.	26 dB
1200 MHz ... 1240 MHz		45	dB	min.	43 dB
1950 MHz ... 1990 MHz		53	dB	min.	28 dB
1990 MHz ... 2025 MHz		52	dB	min.	28 dB
1990 MHz ... 2025 MHz	in OTR2	52	dB	min.	18 dB
3000 MHz ... 3040 MHz		28	dB	min.	15 dB
Return loss within PB at 23 °C		10	dB	min.	8 dB
Return loss in OTR2		10	dB	min.	6 dB
Input power level		-		max.	0 dBm
Operating temperature range	OTR	-			+ 5 °C ... + 70 °C
Operating temperature range 2	OTR2	-			- 20 °C ... + 85 °C
Storage temperature range		-			- 45 °C ... + 85 °C
Temperature coefficient of frequency	TC_f ***	-54	ppm/K		-

*) The terminating impedances depend on parasitics and q-values of matching elements and the board used, and are to be understood as reference values only. Should there be additional questions do not hesitate to ask for an application note or contact our design team.

***) $\Delta f(\text{Hz}) = TC_f(\text{ppm/K}) \times (T - T_0) \times f_{T_0}(\text{MHz})$

Generated:

Checked / Approved:

Tele Filter GmbH
 Potsdamer Straße 18
 D 14 513 TELTOW / Germany
 Tel: (+49) 3328 4784-0 / Fax: (+49) 3328 4784-30
 E-Mail: tft@telefilter.com

VI TELEFILTER reserves the right to make changes to the product(s) and/or information contained herein without notice. No liability is assumed as a result of their use or application. No rights under any patent accompany the sale of any such product(s) or information.

Filter characteristic

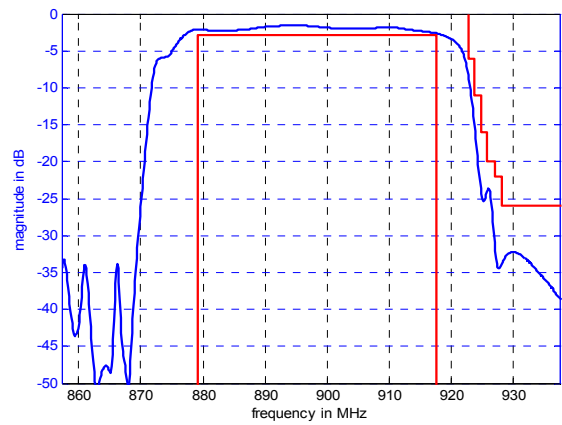
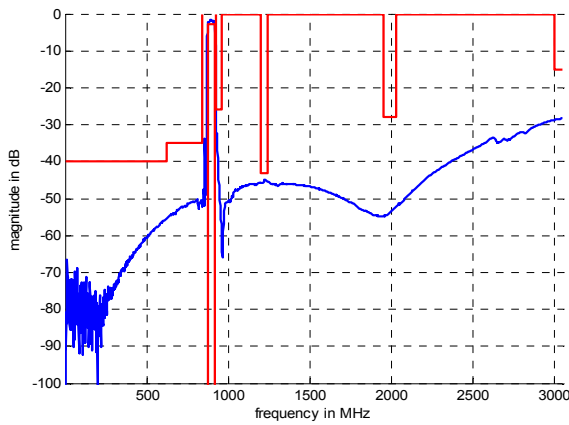

Construction and pin connection

(All dimensions in mm)

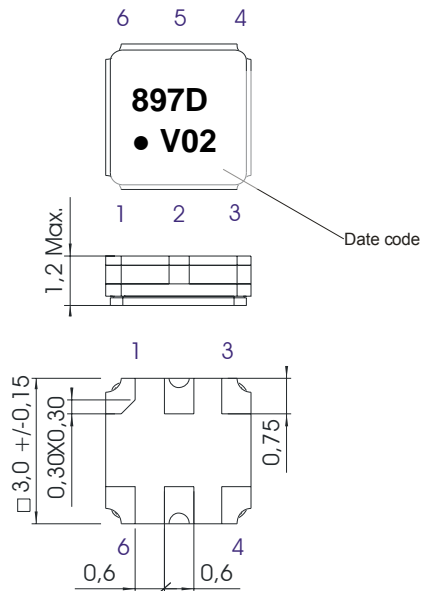

1	Ground
2	Input
3	Ground
4	Ground
5	Output
6	Ground

Date code: Year + week

V	2007
W	2008
X	2009
...	

50 Ohm Test circuit

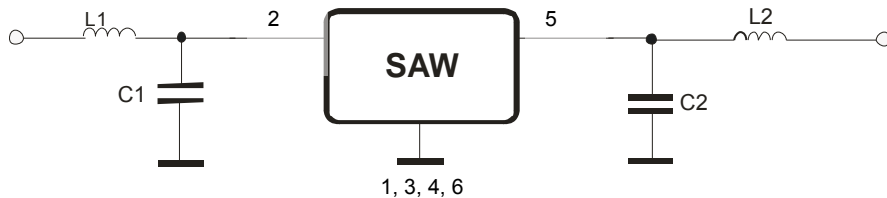

Tele Filter GmbH
 Potsdamer Straße 18
 D 14 513 TELTOW / Germany
 Tel: (+49) 3328 4784-0 / Fax: (+49) 3328 4784-30
 E-Mail: tft@telefilter.com

VI TELEFILTER reserves the right to make changes to the product(s) and/or information contained herein without notice. No liability is assumed as a result of their use or application. No rights under any patent accompany the sale of any such product(s) or information.

Stability characteristics, reliability

After the following tests the filter shall meet the whole specification:

1. Shock: 500g, 1 ms, half sine wave, 3 shocks each plane;
DIN IEC 68 T2 - 27
2. Vibration: 10 Hz to 500 Hz, 0,35 mm or 5 g respectively, 1 octave per min, 10 cycles per plan, 3 plans;
DIN IEC 68 T2 - 6
3. Change of temperature: -55 °C to 125°C / 30 min. each / 10 cycles
DIN IEC 68 part 2 – 14 Test N
4. Resistance to solder heat (reflow): reflow possible: twice max.;
for temperature conditions refer to the attached "Air reflow temperature conditions" on page 4;

This filter is RoHS compliant (2002/95/EG, 2005/618/EG)

Packing

Tape & Reel: IEC 286 – 3, with exception of value for N and minimum bending radius;
tape type II, embossed carrier tape with top cover tape on the upper side;

max. pieces of filters per reel:	9000
reel of empty components at start:	min. 300 mm
reel of empty components at start including leader:	min. 500 mm
trailer:	min. 300 mm

Tape (all dimensions in mm)

- W : 8,00 ± 0,3
- Po : 4,00 ± 0,1
- Do : 1,50 +0,1/-0
- E : 1,75 ± 0,1
- F : 3,50 ± 0,05
- G(min) : 0,75
- P2 : 2,00 ± 0,05
- P1 : 4,00 ± 0,1
- D1(min) : 1,50
- Ao : 3,25 ± 0,1
- Bo : 3,25 ± 0,1
- Ct : 5,5 ± 0,1

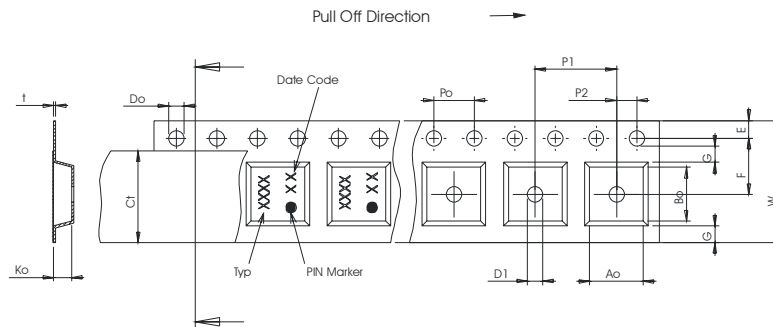

Reel (all dimensions in mm)

- A : 330
- W1 : 8,4 +1,5/-0
- W2(max) : 14,4
- N(min) : 50
- C : 13,0 +0,5/-0,2

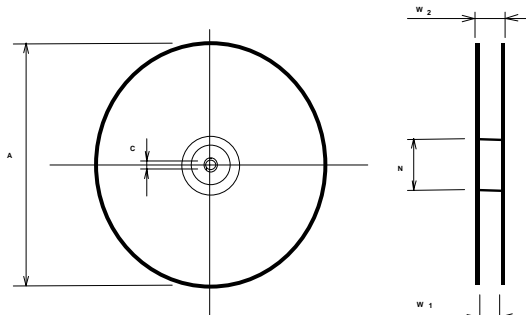

The minimum bending radius is 45 mm.

Tele Filter GmbH
Potsdamer Straße 18
D 14 513 TELTOW / Germany
Tel: (+49) 3328 4784-0 / Fax: (+49) 3328 4784-30
E-Mail: tft@telefilter.com

VI TELEFILTER reserves the right to make changes to the product(s) and/or information contained herein without notice. No liability is assumed as a result of their use or application. No rights under any patent accompany the sale of any such product(s) or information.

Air reflow temperature conditions

Conditions	Exposure
Average ramp-up rate (30°C to 217°C)	less than 3°C/second
> 100°C	between 300 and 600 seconds
> 150°C	between 240 and 500 seconds
> 217°C	between 30 and 150 seconds
Peak temperature	max. 260°C
Time within 5°C of actual peak temperature	between 10 and 30 seconds
Cool-down rate (Peak to 50°C)	less than 6°C/second
Time from 30°C to Peak temperature	no greater than 300 seconds

Chip-mount air reflow profile

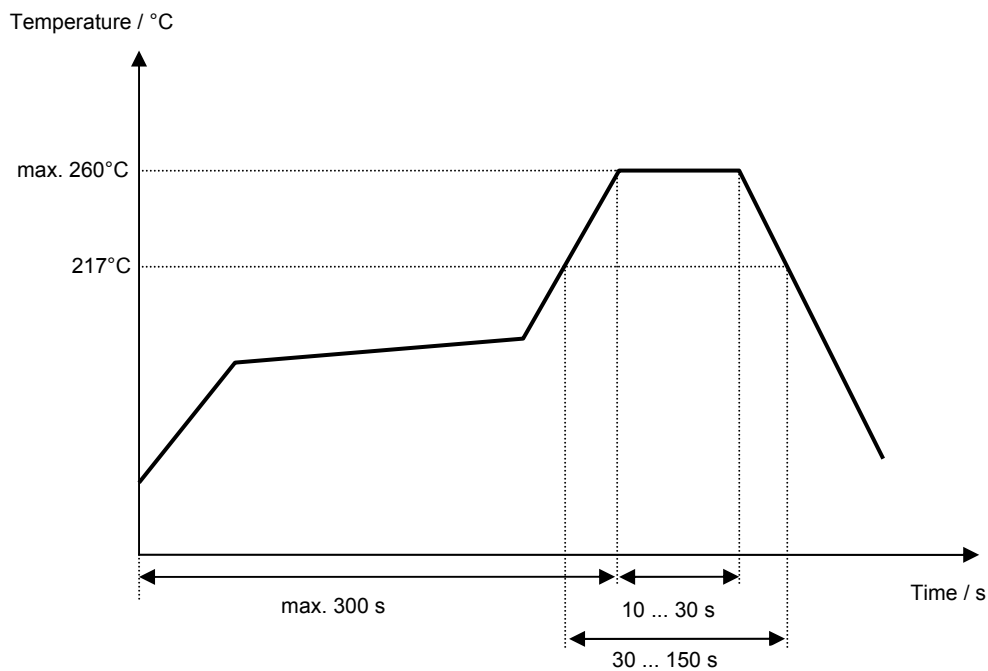

VI TELEFILTER**Filter specification****TFS 897D****5/5****History**

Version	Reason of Changes	Name	Date
1.0	Generation of development specification	Strehl	03.07.2006
1.1	Add the data for the full OTR (OTR2) and change construction	Strehl	12.07.2006
1.2	Add terminating impedances, typical values, filter characteristics and matching configuration Generation of filter specification	Noack	11.01.2007
1.3	Change data table (Add values for the OTR2 temperature range)	Noack	09.10.2008
1.4	power durability significantly reduced	Springfeld	07.08.2009

Tele Filter GmbH
Potsdamer Straße 18
D 14 513 TELTOW / Germany
Tel: (+49) 3328 4784-0 / Fax: (+49) 3328 4784-30
E-Mail: tft@telefilter.com

VI TELEFILTER reserves the right to make changes to the product(s) and/or information contained herein without notice. No liability is assumed as a result of their use or application. No rights under any patent accompany the sale of any such product(s) or information.