

Helping Customers Innovate, Improve & Grow



## Description

The TX-707 Series TCXO combines innovative manufacturing and the latest technology to provide low phase noise and excellent g-sensitivity. The fully hermetic assembly includes a dual crystal circuit to cancel opposing g-sensitivity vectors enclosed in a 5x7mm ceramic package.

## Features

- Operating Temperature Range to +105°C
- Low Phase Noise, Low g-sensitivity 0.1ppb/g
- Fully RoHS Compliant
- Surface Mount, Low Profile
- High Shock Survival up to 20k g
- Frequency Range: 8.184 MHz to 50 MHz
- Fully Hermetic Seal

## Applications

- Military Portable Radios
- GPS Telemetry
- Test and Measurement Equipment
- Missile systems
- GNSS
- SATCOM



## Performance Specifications

Parameter	Min	Typ	Max	Units	Condition
<b>Frequency Stabilities<sup>1</sup></b>					
vs. operating temperature range (referenced to +25°C)	-1.0		+1.0	ppm	-40... +85°C
Initial Tolerance	-1.0		+1.0	ppm	at time of shipment, nominal EFC Vs ± 5% Load ± 10% @ +40°C for 15 years
vs. supply voltage change	-0.2		+0.2	ppm	
vs. load change	-0.2		+0.2	ppm	
vs. aging / 1 year		±1		ppm	
vs. aging			4.0	ppm	
<b>Supply Voltage (Vs)</b>					
Supply voltage	4.75	5.0	5.25	VDC	
Supply voltage	3.135	3.3	3.465	VDC	
Current consumption		5	10	mA	Increases with output frequency

## Performance Specifications

Parameter	Min	Typ	Max	Units	Condition
<b>RF Output</b>					
Signal	HCMOS				
Load		15		pF	
Signal Level (Vol)			0.1*Vs	V	
Signal Level (Voh)	0.9*Vs			V	
Rise/Fall Time			5	ns	@ nominal Load and 10% to 90% of waveform
Duty cycle	40	50	60	%	@ nominal Load and @ 50% level
Signal	Clipped Sinewave				Frequencies greater than 15 MHz only.
Level		1		Vpp	with nominal Load
Load R		10		kohm	
Load C		10		pF	
<b>Electronic Frequency Control (EFC)</b>					
Tuning Range (options A, C)	Fixed; No adjust				
Tuning Range (options B, D)	±5.0		±12	ppm	
Tuning Slope	Positive				
Control Voltage Range	0.0		Vs	VDC	
Freq. control input impedance	10			kohm	
<b>RF Output Enable / Disable (Pin 4)</b>					
RF Output Enabled	Logic "1" or no connect				
RF Output Disabled	Logic "0"				
<b>Additional Parameters<sup>1</sup></b>					
Phase Noise <sup>3</sup> (@ 10 MHz - no vibration)		-100		dBc/Hz	10 Hz
		-128		dBc/Hz	100 Hz
		-149		dBc/Hz	1 kHz
		-158		dBc/Hz	10 kHz
		-160		dBc/Hz	100 kHz
Phase Noise <sup>3</sup> (@ 50 MHz - no vibration)		-82		dBc/Hz	10 Hz
		-113		dBc/Hz	100 Hz
		-135		dBc/Hz	1 kHz
		-151		dBc/Hz	10 kHz
		-155		dBc/Hz	100 kHz
g-sensitivity		0.2		ppb/g	per axis (ordering code A and B)
			0.1	ppb/g	per axis (ordering code C and D) parts 100% tested with 100 Hz sine vibration
Shock					MIL-STD-883G; Method 2002.4; Condition F
Vibration Sine					MIL-STD-202G, METHOD 204D, Test Condition D
Thermal Cycling					MIL-STD-202, METHOD 107, Test Condition A
<b>Absolute Maximum Ratings</b>					
Supply voltage (Vs)			6.0	V	Damage will occur beyond this level
Control Voltage	0		Vs	V	
Operable temperature range	-45		+105	°C	
Storage temperature range	-55		+105	°C	

# Static Phase Noise Performance

## 10 MHz (Static)

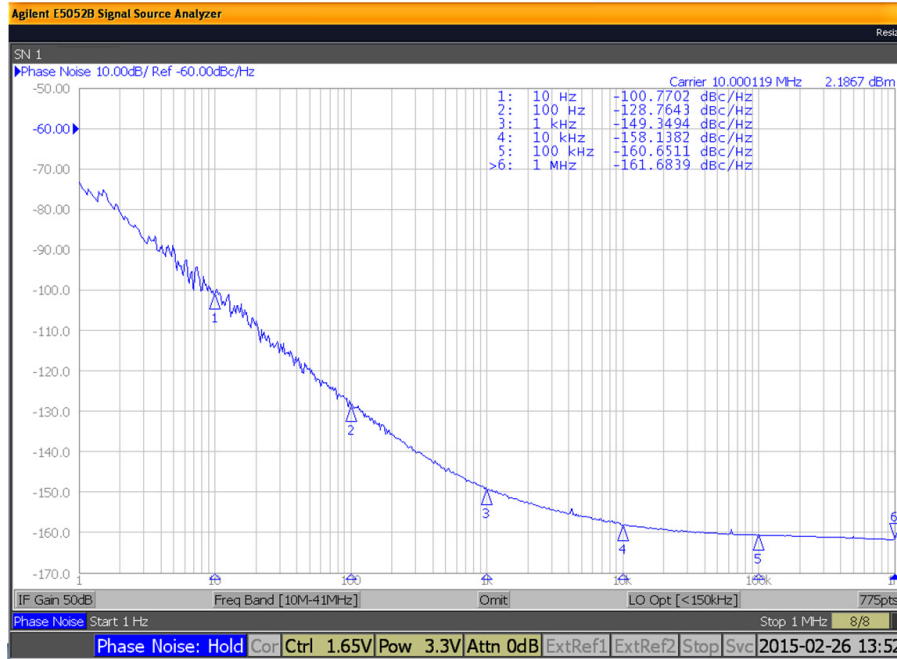

# G-Sensitivity Performance

TX-7070-EAE-206C-10M000000

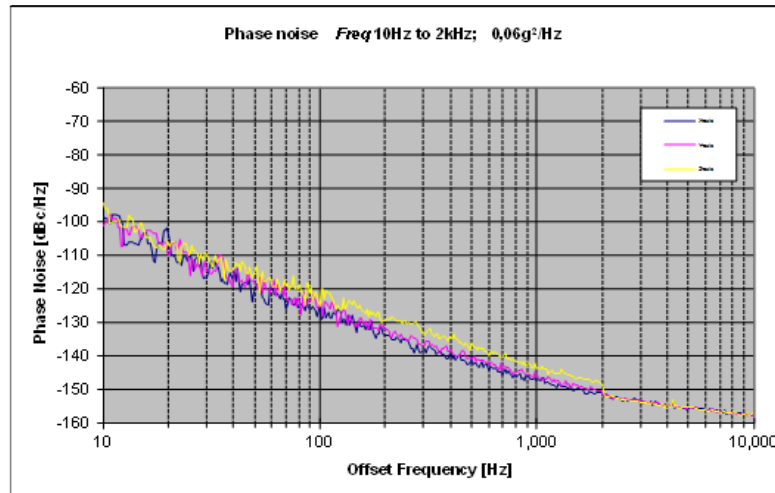
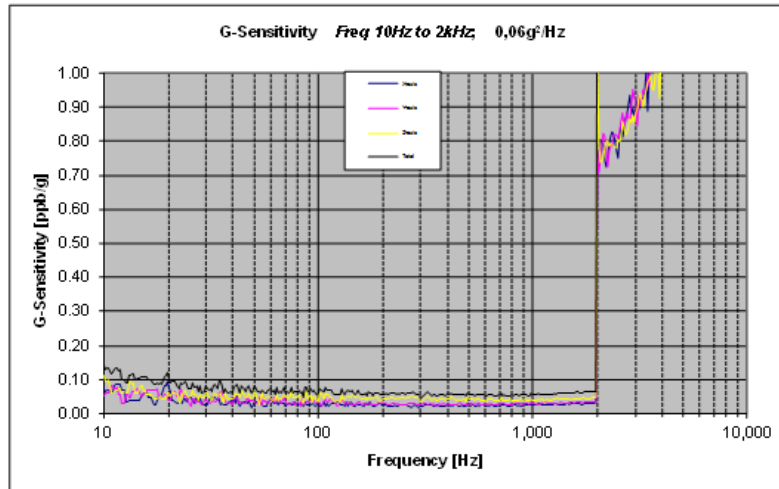

# Static Phase Noise Performance

50 MHz (Static)

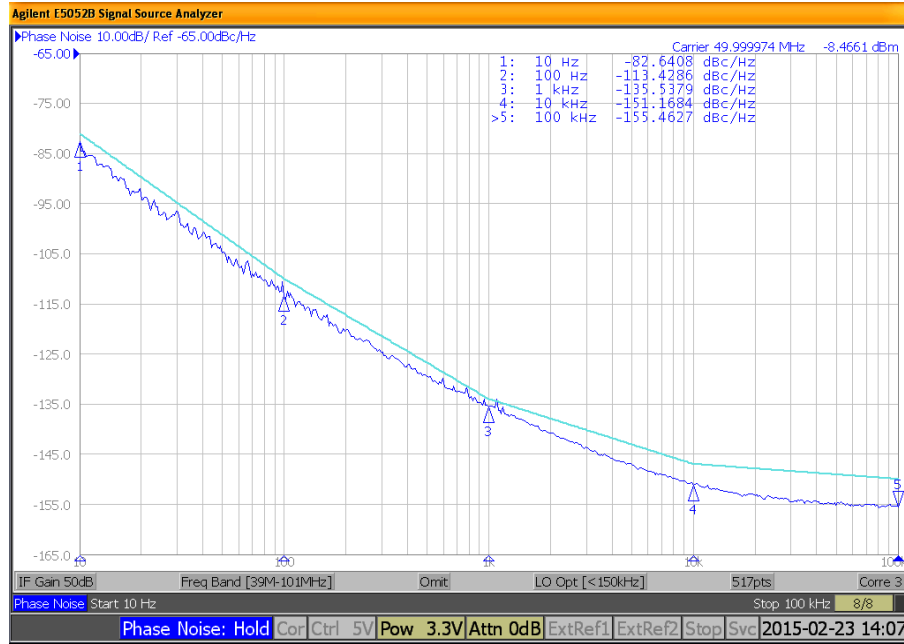

# G-Sensitivity Performance

TX-707-50M000000

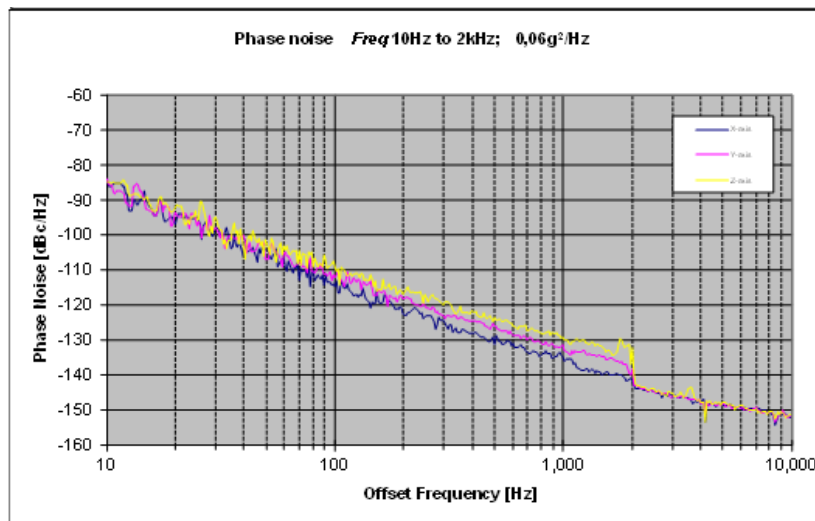
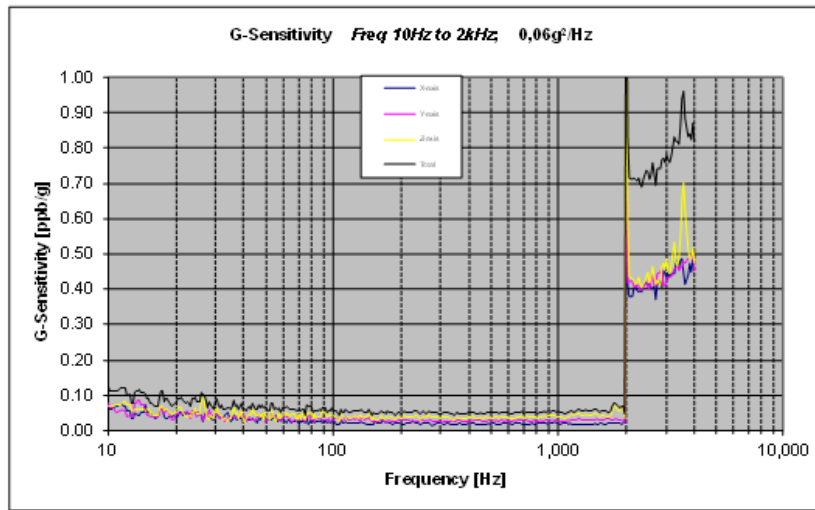

# Standard Shipping Method

Tape and Reel Information											
Tape Dimensions (mm)					Reel Dimensions (mm)						
W	F	Do	Po	P1	A	B	C	D	N	W1	W2
16	7.5	1.5	4	8	180	1.5	13	20.2	60	16.4	20.4

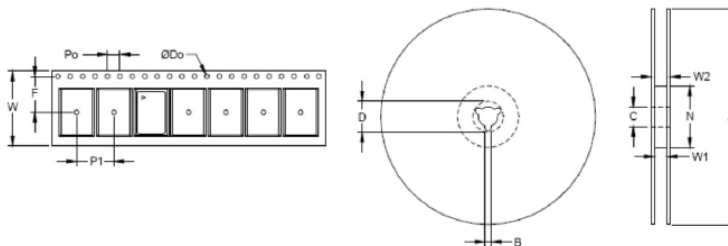

## Outline Drawing / Enclosure

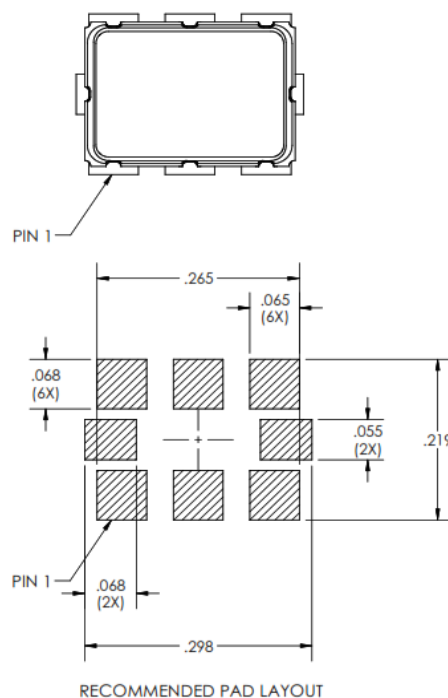
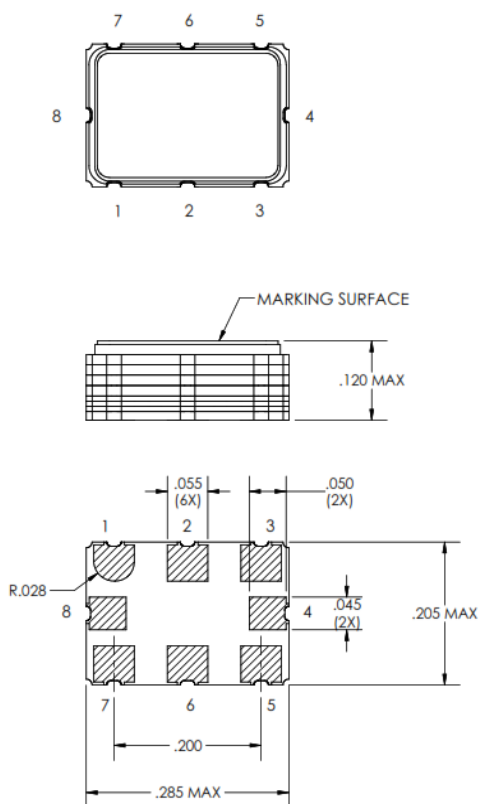

### Plating Composition of TX-707 pads:

30-90 microinches electroless Gold over 50-350 microinches electroless Nickel  
Contact factory for tin dipped parts. Tinning increases overall height of units to 0.130 Max

### Dimensions in inches

1	Electronic Frequency Control (EFC) Option or No Connect*
2	No connect*
3	Ground
4	RF Output Enable / Disable Function+
5	RF Output
6	No Connect*
7	Supply Voltage
8	No Connect*

\* Do not connect to this pin - Vectron reserved

+ if customer does not intend to use the enable functional tie this pin to Vcc or allow it to float.

## Recommended Reflow Profiles for Pb-Free & Sn-Pb

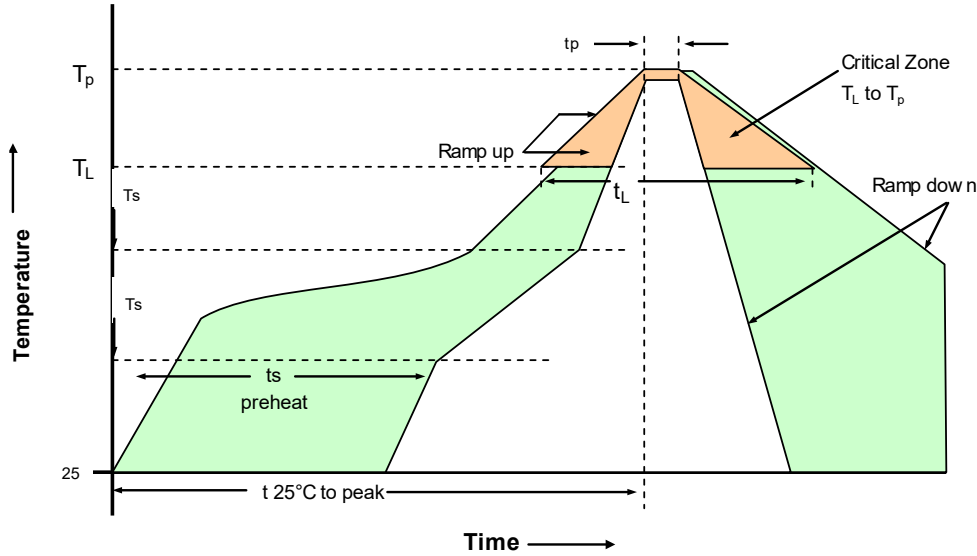

### 230°C Reflow Profile

Profile Feature	Sn-Pb Assembly	Profile Feature	Sn-Pb Assembly
Average ramp-up rate (TL to TP)	3°C/secod max.	Time 25°C to Peak Temperature	4 minutes max.
Preheat - Temperature min T <sub>sm</sub> - Temperature Min T <sub>sm</sub> - Time (min to max) (t <sub>s</sub> )	135°C 155°C 60-90 seconds	Time maintained above - Temperature (TL) - Time (t <sub>L</sub> )	183°C 45-60 seconds
T <sub>sm</sub> to TL -Ramp-up Rate	3°C/secod max.		
Time maintained above - Temperature (TL) - Time (TL)	183°C 40-60 seconds	Time within 5°C of actual Peak Temperature (t <sub>p</sub> )	10-20 seonds max.
Peak Temperature (T <sub>p</sub> )	max 230°C	Ramp-down Rate	6°C/second max.

**Note:** All temperatures refer to toposide of the package, measured on the package body surface.

### 260°C Reflow Profile

Profile Feature	Pb-Free Assembly	Profile Feature	Pb-Free Assembly
Average ramp-up rate (TL to TP)	3°C/secod max.	Time 25°C to Peak Temperature	8 minutes max.
Preheat - Temperature min T <sub>sm</sub> - Temperature min T <sub>sm</sub> - Time (min to max) (t <sub>s</sub> )	150°C 200°C 60-180 seconds	Time maintained above - Temperature (TL) - Time (t <sub>L</sub> )	217°C 60-150 seconds
T <sub>sm</sub> to TL -Ramp-up Rate	3°C/secod max.		
Time maintained above - Temperature (TL) - Time (TL)	217°C 60-150 seconds	Time within 5°C of actual Peak Temperature (t <sub>p</sub> )	20-40 seonds max.
Peak Temperature (T <sub>p</sub> )	max 260°C	Ramp-down Rate	6°C/second max.

**Note:** All temperatures refer to toposide of the package, measured on the package body surface.

# Ordering Information

## TX - 7070 - E A E - 106 A - 10M0000000

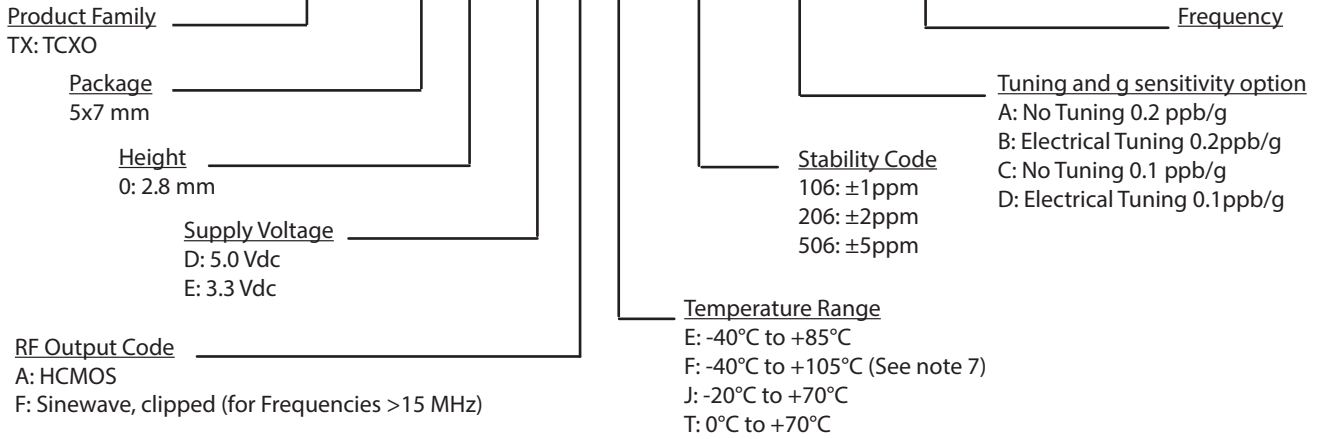

Available Standard Frequencies (MHz) <sup>6</sup>			
8.184	9.600	10.000	12.500
16.368	19.200	20.000	25.000
32.736	38.400	40.000	50.000

Vectron Standard TX-707 Part Numbers		
TX-7070-EAE-106A-10M0000000	TX-7070-EAE-106C-20M0000000	TX-7070-EAE-106C-40M0000000
TX-7070-EAE-106C-10M0000000	TX-7070-DAE-106D-25M0000000	TX-7070-EAE-106D-40M0000000
TX-7070-EAE-106D-10M0000000	TX-7070-EAE-106A-25M0000000	TX-7070-EFE-106C-40M0000000
TX-7070-EAE-206C-10M0000000		TX-7070-EAE-106A-50M0000000
TX-7070-EFE-106C-16M3680000		TX-7070-EAE-106C-50M0000000
TX-7070-EFE-106D-16M3680000		TX-7070-EAE-106D-50M0000000
		TX-7070-EFE-106D-50M0000000
		TX-7070-EFE-206A-50M0000000

**Notes:**

- Contact factory for improved stabilities or additional product options. Not all options and codes are available at all frequencies.
- Unless otherwise stated, all values are valid after warm-up time and refer to typical conditions for supply voltage, frequency control voltage, load, and temperature (25°C).
- Phase noise degrades with increasing output frequency.
- Subject to technical modification.
- Contact factory for availability.
- Frequencies not listed above will require NRE charges and additional lead times.
- Only available with 506 stability Code.

## For Additional Information, Please Contact

**USA:**

Vectron International  
267 Lowell Road, Unit 102  
Hudson, NH 03051  
Tel: 1.888.328.7661  
Fax: 1.888.329.8328

**Europe:**

Vectron International  
Landstrasse, D-74924  
Neckarbischofsheim, Germany  
Tel: +49 (0) 3328.4784.17  
Fax: +49 (0) 3328.4784.30

**Asia:**

Vectron International  
68 Yin Cheng Road(C), 22nd Floor  
One LuJiaZui  
Pudong, Shanghai 200120, China  
Tel: +86 21 6194 6886  
Fax: +86 21 6194 6699

**Disclaimer**

Vectron International reserves the right to make changes to the product(s) and or information contained herein without notice. No liability is assumed as a result of their use or application. No rights under any patent accompany the sale of any such product(s) or information.

9-29-2017 JV